



Super**Systems**  
incorporated

**MGA 6010**  
**Multi-Gas IR Analyzer**  
(CO, CO<sub>2</sub>, and CH<sub>4</sub> Gas Analyzer  
with Optional H<sub>2</sub> Measurement and  
% Carbon, % Dissociated Ammonia, % NH<sub>3</sub>, K<sub>N</sub>, and  
K<sub>C</sub> Calculation Capabilities)

**Operations Manual**

Please read, understand, and follow these instructions before operating this equipment.  
Super Systems, Inc. is not responsible for damages incurred due to a failure to comply with these instructions. If at any time there are questions regarding the proper use of this analyzer, please contact us at 513-772-0060 for assistance.

**Super Systems Inc.**

USA Office

*Corporate Headquarters:*

7205 Edington Drive

*Shipping Address:*

7245 Edington Drive

Cincinnati, OH 45249

Phone: (513) 772-0060

<http://www.supersystems.com>

**Super Systems Europe**

Unit E, Tyburn Trading Estate,

Ashold Farm Road, Birmingham

B24 9QG

UNITED KINGDOM

Phone: +44 (0) 121 306 5180

<http://www.supersystemeurope.com>

**Super Systems México**

Sistemas Superiores Integrales S de RL de CV

Acceso IV No. 31 Int. H Parque Industrial

Benito Juarez

C.P. 76120 Queretaro, Qro.

Phone: +52 442 210 2459

<http://www.supersystems.com.mx>

**Super Systems China**

No. 369 XianXia Road

Room 703

Shanghai, CHINA

200336

Phone: +86 21 5206 5701/2

<http://www.supersystems.cn>

**Super Systems India Pvt. Ltd.**

A-26 Mezzanine Floor, FIEE Complex,

Okhla Indl. Area, Phase - 2

New Delhi, India 110 020

Phone: +91 11 41050097

<http://www.supersystemsindia.com>

<b>Table of Contents</b>	
<b>Introduction</b> .....	<b>5</b>
<b>Specifications</b> .....	<b>6</b>
<b>Unpacking the Device</b> .....	<b>7</b>
<b>Mechanical Installation</b> .....	<b>7</b>
Enclosure Mounting .....	7
<b>Wiring Connections</b> .....	<b>8</b>
Plumbing Connections .....	9
<b>Basic Operating Description</b> .....	<b>11</b>
<b>Default Screen</b> .....	<b>11</b>
<b>Pump Operation</b> .....	<b>12</b>
<b>Carbon Calculation</b> .....	<b>12</b>
<b>Chart</b> .....	<b>13</b>
Chart Sub Menu .....	14
<b>Menu Lists</b> .....	<b>15</b>
Carbon Calculation .....	16
Nitrider Calculation (Available on Units Configured for Nitriding & FNC Applications) .....	17
Sessions .....	18
Pump Control .....	20
Sensor Calibration .....	20
Performing a Zero Calibration .....	23
Performing a Span Calibration .....	24
Automatic Sampling Parameters .....	24
COF/PF Adjustment Increment .....	24
COF/PF Adjustment Interval (minutes) .....	25
Minimum COF / PF Value .....	25
Maximum COF / PF Value .....	25
COF / PF Adjustment Mode .....	25
Minimum Temperature for sampling (0 = disabled) .....	25
Communications and Source Setup .....	26
IP Address .....	26
Atmosphere/Temp Sources .....	27
Port Setup .....	28
Instrument Setup .....	29
Calculation Factors .....	29
General Setup .....	35
Security Settings .....	35
Analog Output Setup .....	36
Factory Default Settings .....	36
Other Settings .....	36
Language Setup .....	36
Auto Calibration Setup .....	37
Gas Alarm Setup .....	38
Instrument Information .....	38
General Information .....	38
Calibration Dates .....	39
Power Status .....	39
Tools .....	39
Database Maintenance .....	39
Pressure Sensor Calibration .....	40
Thermister Calibration .....	40
SuperCalc .....	40
Set User Cal / Load User Cal .....	40
Valve Setup .....	41
Shut Down Interface .....	41
<b>Parts List and Internal Components</b> .....	<b>42</b>

Revision History .....	45
Appendix A: Piping Diagram.....	46
Appendix B: Digital Inputs on the MGA 6010 .....	47
Appendix C: Modbus Registers .....	48
Appendix D: Configuration Parameters .....	66

## Introduction

The Model MGA 6010 (see part numbers in the Parts List on page 42) is a Multi-Gas IR analyzer. It measures Carbon Monoxide (CO), Carbon Dioxide (CO<sub>2</sub>) and Natural Gas (CH<sub>4</sub>) typically found in an endothermic atmosphere. The measurement of these gases, combined with furnace temperature information, allows the MGA 6010 to calculate the percent Carbon (%C) of the measured gas. A Hydrogen (H<sub>2</sub>) sensor can also be incorporated as an option to provide a more complete picture of the measured gas.

For nitriding and ferritic nitrocarburizing (FNC) applications, the MGA 6010 can calculate carburizing potential (K<sub>C</sub>) and nitriding potential (K<sub>N</sub>).

Finally, the MGA 6010 can be configured for compatibility with environments containing ammonia (NH<sub>3</sub>) gas. NH<sub>3</sub> compatibility must be specifically requested when the MGA 6010 is ordered.

NOTE: Calculation of K<sub>C</sub> may have inaccuracies in the presence of ammonia.

### **IMPORTANT!**

Do not use a MGA 6010 for gas analysis with NH<sub>3</sub>-containing gas if the MGA 6010 has not been configured with NH<sub>3</sub> compatibility. Any use of a non-NH<sub>3</sub> compatible MGA 6010 with NH<sub>3</sub>-containing gas will void the product warranty.



## Specifications

The unit is designed and manufactured for the atmosphere heat treating industry; however, its uses go beyond the scope of these applications.

### **CO:**

Range: 0 – 30% of gas concentration.

Accuracy: +/-1% of full scale (+/-0.3% of gas concentration, based on 30%).

Resolution: 0.01%

### **CO2 Low:**

Range: 0 – 2% of gas concentration.

Accuracy: +/-1% of full scale (+/-0.02% of gas concentration, based on 2%).

Resolution: 0.001%

### **CO2 High:**

Range: 0 – 20% of gas concentration.

Accuracy: +/-1% of full scale (+/-0.2% of gas concentration, based on 20%).

Resolution: 0.01%

**CH4:**

Range: 0 – 20% of gas concentration.

Accuracy: +/-1% of full scale (+/-0.2% of gas concentration, based on 20%).

Resolution: 0.01%

**H2:**

Range: 0 – 100% of gas concentration.

Accuracy: +/-1% of full scale (+/-1% of gas concentration, based on 100%).

Resolution: 0.1%

***\* Note: These sensors have been optimized for use at the levels normally seen in an Endothermic atmosphere. The ranges can be adjusted to fit other applications. For information regarding modifications to the ranges shown above, please contact Super Systems.***

Sampling method:	Extraction by internal pump (when necessary)
Measurement Method (CO, CO <sub>2</sub> , CH <sub>4</sub> ):	Non-Dispersive Infrared (NDIR)
Measurement Method (H <sub>2</sub> ):	Thermal Conductivity
Repeatability:	± 1% of full scale
Recommended Calibration Interval:	Annual
AC Power Requirements:	110VAC (can be modified to 220V upon request)
Communications:	Ethernet, USB(A), USB(B), RS485 Modbus
Data Storage:	Continuous automatic data logging
Data Retrieval:	XGA Viewer Software (included) or on-screen
Operating Temperature:	32° to 122° F (0° to 50° C)
External Dimensions:	Approx. 16" H X 20" L X 8" D
Weight:	Approx. 28 lbs.

## Unpacking the Device

The following items should be included with the MGA:

- (1) MGA 6010 Gas Analyzer
- (1) Bowl Filter Assembly (attach to "Sample Inlet" port)
- (1) ¼" Male NPT to 3/16" barb fitting (attach to "Aux. Cal. Gas Inlet" if desired)
- (1) Operations Manual
- (1) XGA Viewer CD
- (2) ¼" Male NPT to calibration gas inlet hose fitting (attach to "Zero and Span Cal. Gas Inlet" if desired)

If any of these items is missing or damaged please contact Super Systems Inc. at 513-772-0060.

## Mechanical Installation

### Enclosure Mounting

It is recommended that the MGA 6010 be mounted as close to the sampling point as possible, since that will reduce the length of the plumbing lines that will need to be maintained. It is intended for use in a heat treating environment, but care should be taken not to mount it too close to a furnace or other heat source. The operating temperature of the enclosure should be maintained below 122°F (50°C). If necessary, a heat shield can be mounted behind the enclosure to reduce the amount of radiant heat that the MGA is exposed to. In most cases, this will not be necessary.

The enclosure is heavily vented to prevent the buildup of potentially harmful gases in the unlikely event of an internal leak. This venting will also reduce the internal temperature by allowing the free flow of ambient air around the internal components.

## Wiring Connections

Terminal blocks inside the instrument are available for the following purposes:

1000	○		○	1000	INCOMING LINE
1002	○		○	1002	INCOMING NUETRAL
GND	○	○	○	GND	INCOMING GROUND
2311	○		○	2311	SYSTEM ALARM #01 CONTACT
2312	○		○	2312	SYSTEM ALARM #01 CONTACT
2341	○		○	2341	SYSTEM ALARM #02 CONTACT
2342	○		○	2342	SYSTEM ALARM #02 CONTACT
1540	○		○	1540	COMMS TO IR-143, MTX-303, AND HS-403 (RS-485)
1550	○		○	1550	COMMS TO IR-143, MTX-303, AND HS-403 (RS-485)
1560	○		○	1560	COMMS TO EXTERNAL CLIENT INSTRUMENT(S) (RS-485)
1570	○		○	1570	COMMS TO EXTERNAL CLIENT INSTRUMENT(S) (RS-485)
3661	○		○	3661	DIGITAL INPUT #04
1080	○		○	1080	DIGITAL INPUT COMMON
3681	○		○	3681	DIGITAL INPUT #03
3701	○		○	3701	DIGITAL INPUT #02
1080	○		○	1080	DIGITAL INPUT COMMON
3721	○		○	3721	DIGITAL INPUT #01
4101	○		○	4101	H2 SENSOR ANALOG OUTPUT #01 %HYDROGEN (4-20mA)
4111	○		○	4111	H2 SENSOR ANALOG OUTPUT COMMON
4121	○		○	4121	H2 SENSOR ANALOG OUTPUT #02 SPARE (4-20mA)
4481	○		○	4481	ANALOG OUTPUT #01 CARBON MONOXIDE 0-30% (4-20mA)
4501	○		○	4501	ANALOG OUTPUT #01 CARBON MONOXIDE 0-30% (4-20mA)
4561	○		○	4561	ANALOG OUTPUT #02 CARBON DIOXIDE 0-2% (4-20mA)
4581	○		○	4581	ANALOG OUTPUT #02 CARBON DIOXIDE 0-2% (4-20mA)
4641	○		○	4641	ANALOG OUTPUT #03 METHANE 0-30% (4-20mA)
4661	○		○	4661	ANALOG OUTPUT #03 METHANE 0-30% (4-20mA)
4721	○		○	4721	ANALOG OUTPUT #04 CARBON 0-2% (4-20mA)
4741	○		○	4741	ANALOG OUTPUT #04 CARBON 0-2% (4-20mA)

Each terminal block is numbered according to the included electrical drawing. Knockout holes in the enclosure have been provided to simplify wiring connections. Knockouts are located on the bottom of the enclosure. Additional or alternate locations can be added as needed. Please note that due to the potential for electrical interference, it is recommended that communication wires not be run in parallel to AC power wires.

The right side of the enclosure also contains two Ethernet ports, one USB A port and one USB B port. These can be used to communicate to the MGA 6010. For detailed information on the use of these ports, please see the section of this manual, Communications and Source Setup.

Electrical drawings are available from SSi at:

<http://www.supersystems.com/documentation/schematics-and-drawings/>



## Plumbing Connections

There are five plumbing connections on the MGA 6010:

- Sample Inlet – The incoming gas to be sampled should be routed through this port after passing through the included bowl filter.
- Sample Vent – After sampling, the gas will exit the enclosure through this port. Due to the potentially harmful nature of the gas being measured, the gas should be vented to a place in accordance with local regulations and safety standards.
- Zero and Span Calibration Gas Inlets – These are ¼” NPT female ports for connecting to calibration gases. For more information on acceptable calibration gases see the Sensor Calibration section of this manual. The incoming pressure of the gas will need to be adjusted to allow the flow to be the same for the calibration gas and the sample gas flow rate. The incoming pressurized gas goes through a small fixed orifice inside the analyzer, which should require between 20 and 50 psi to maintain proper flow. These ports are used with the automatic calibration system to provide calibrations at predetermined intervals or events. The use of these ports is not required for the operation of the MGA 6010.
- Auxiliary Calibration Gas Inlet – This ¼” NPT female port provides another entry point for both zero and span calibration gases. If calibrations are being performed manually, this port should be used for both gases.

The flow of gas through the MGA 6010 is controlled by solenoid valves. Each valve is normally closed, and for safety purposes all valves will shut to prevent unwanted furnace gases from entering the instrument when power to the enclosure is lost or the specified sampling parameters are not met.

Appendix A: Piping Diagram shows the plumbing connections.

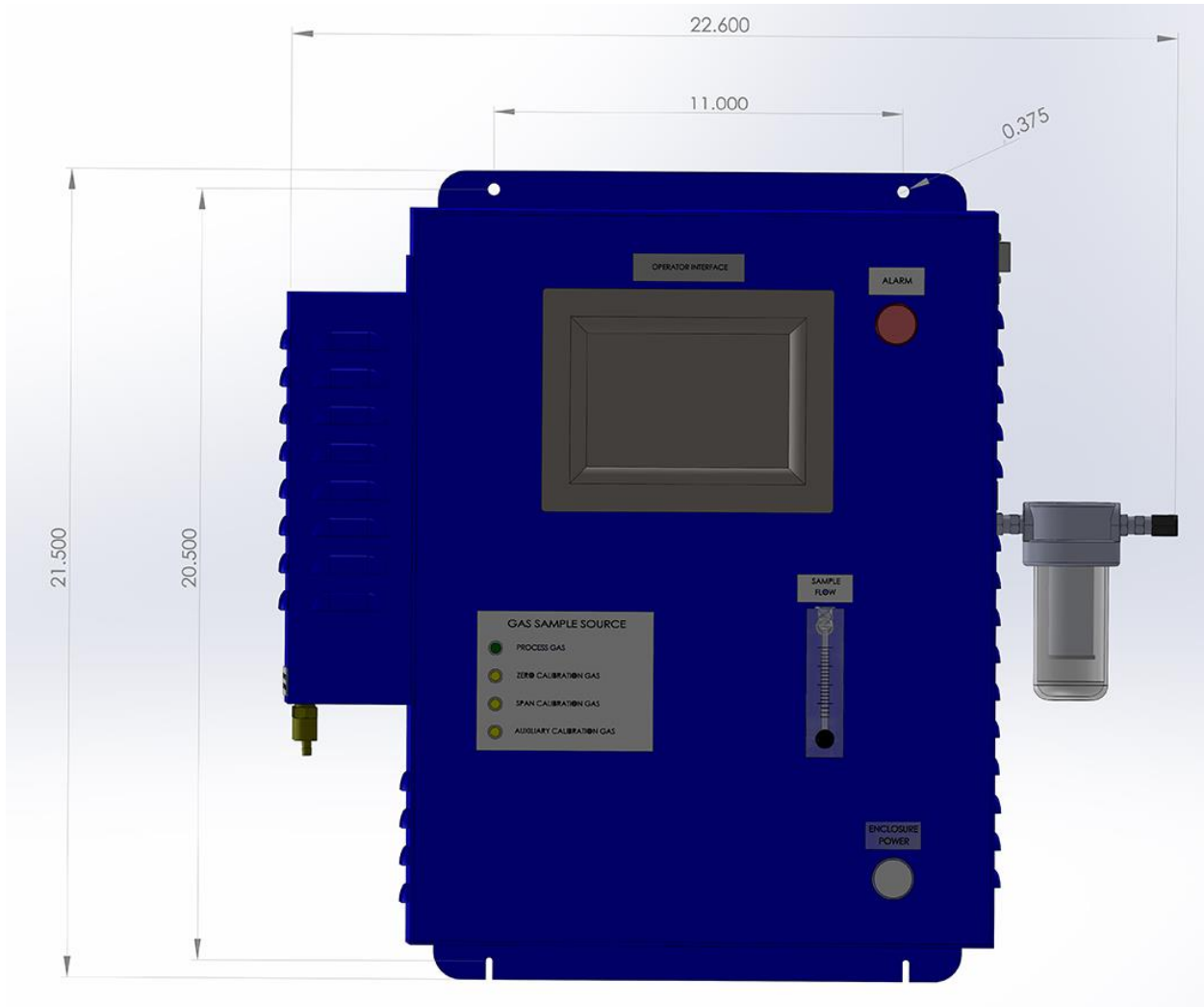

## Basic Operating Description

The Model MGA 6010 has been designed for the simultaneous analysis of CO, CO<sub>2</sub> and CH<sub>4</sub> in heat-treat furnace atmosphere gases. It uses a color touch screen display / operator interface for data entry and for viewing. Selections can be made on the screen using a finger or a stylus. Avoid the use of sharp objects (pens, paperclips, screwdrivers, etc.) as they can cause permanent damage to the screen and void the warranty of the instrument.

After the power switch is turned on, it will take approximately 30 seconds for the MGA 6010 software to automatically load. Once the software is properly loaded, the instrument is ready to use. Power to the MGA can be turned off by tripping the circuit breaker inside the enclosure. Before the breaker is tripped, select the "Shut down interface" option from the main menu and allow the screen to close the MGA software in a controlled manner. Doing so will help minimize any damage to data that could be done by an unexpected shutdown.

### Hydrogen Cell Note:

For highest H<sub>2</sub> accuracy, it is recommended that the instrument be powered on for 60 minutes before measurements are taken.

## Default Screen

Once the MGA 6010 has successfully loaded its software, the default screen will be displayed.

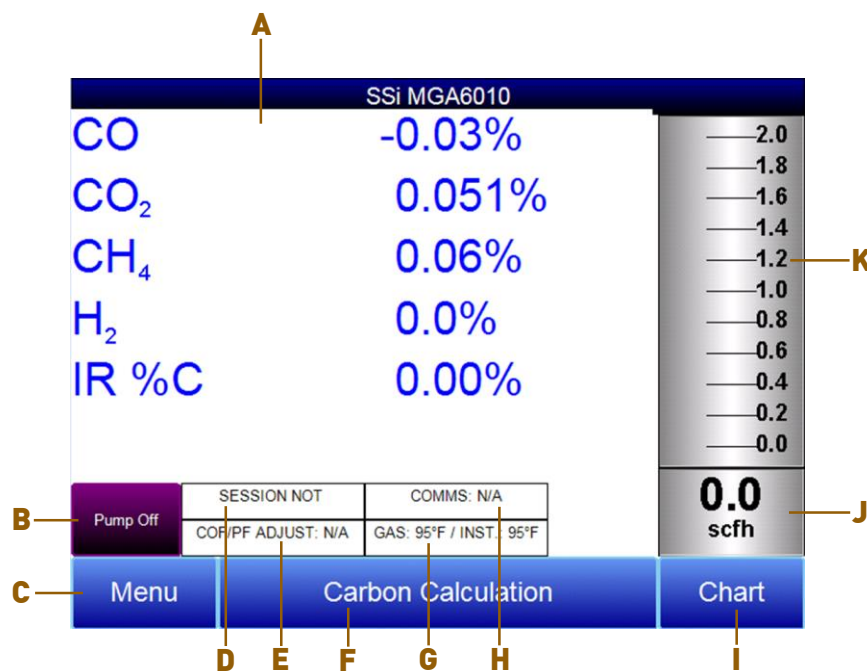

- A – Measured values of CO, CO<sub>2</sub>, CH<sub>4</sub>, and IR %C (and H<sub>2</sub>, if the H<sub>2</sub> sensor is present)
- B – Pump status indicator / Button to change pump status
- C – Button to access menu list
- D – Session status indicator
- E – Temperature / Instrument Temperature indicator
- F – Button for Carbon Calculation screen
- G – Automatic Carbon Calculation Adjustment indicator
- H – External Instrument Communications status indicator
- I – Button for Trend Chart screen

J – Numeric Flow indicator

K – Visual Flow indicator

Pressing the **Return** button at the bottom right of the operator interface on any screen will take the display to the default. It may be necessary to press the **Return** button multiple times.

## Pump Operation

Initially, the pump will be off. The pump should remain off while sampling an endothermic generator or any other atmosphere under positive pressure. The pump should also remain off during calibration. For proper operation, the flow of gas through the sensors should be between 1.0 and 2.0 SCFH. If the flow meter on the right of the screen does not indicate sufficient flow, turn the pump on. When accessed from the main screen, the pump has two possible modes: **Automatic** and **Off**.

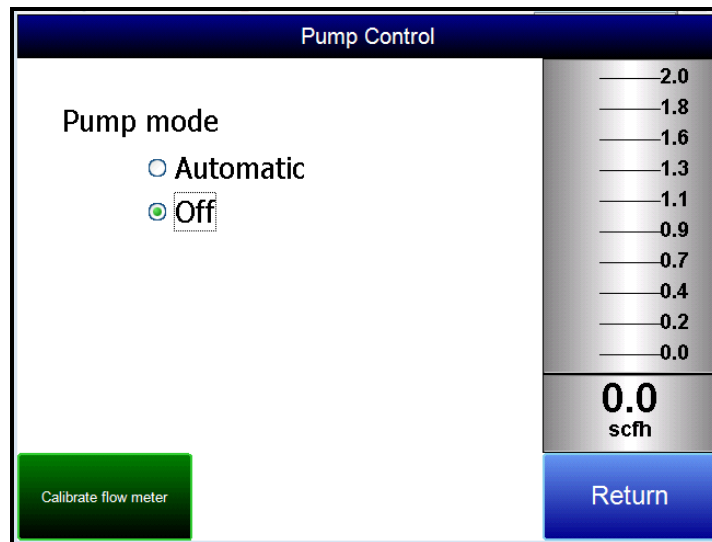

## Carbon Calculation

The MGA 6010 determines the percent carbon in the sample gas using measured amounts of CO, CO<sub>2</sub>, and CH<sub>4</sub> along with the Furnace Temperature. The Furnace Temperature is either entered by the user or obtained automatically from the Furnace Temperature Controller via RS-485 communications.

Additionally, the carbon percentage measured by the MGA 6010 can be used as a comparison to the carbon percentage measured by a furnace's oxygen probe. This is accomplished either by manually entering the Probe Temperature, Probe Millivolts, and the Probe CO Factor into the MGA 6010 or by obtaining the information automatically via RS-485 communications to the Furnace Carbon Controller. Providing the probe information allows the MGA 6010 to suggest an adjustment for the probe CO Factor (or Process Factor) in order to keep the oxygen probe measuring properly.

Carbon Calculation			
Furnace	1701 °F	Probe Temperature	1698 °F
Measured CO	21.88 %	Probe Millivolts	1072 mV
Measured CO2	0.737 %	%C (probe)	0.28 %
Measured CH4	8.55 %	Probe CO Factor	200
%C (gas analyzer)	0.27 %	Suggested CO Factor	191
Pump Off	SESSION NOT ENABLED	COMMS: N/A	
	GAS: 104°F / INST.: 101°F	COF/PF ADJUST: N/A	
		Chart	Return

Using infra-red analysis is considered a more accurate method for determining the percent carbon of a gas compared to using an oxygen probe alone. The single point oxygen probe assumes a theoretical mixture of endothermic gas to infer the percent carbon whereas the gas analyzer will measure the exact composition of the process gas. The percent carbon determined by the gas analyzer can then be used to adjust the carbon percentage determined by the oxygen probe.

## Chart

The Chart Display shows between 1 hour and 24 hours of process variable data on the screen and can be scrolled back to view all of the data stored on the flash card. The vertical timelines change as the time changes on the screen. The function buttons run along the bottom of the screen.

The Trend Lines button -  - will allow the user to select or de-select the trend lines on the trend chart to display. If the checkbox next to each trend line is checked, then that trend line will be displayed.

The Datagrid View button -  - will display a screen with the trend data in a grid format instead of with trend lines. The trend data is shown in 1-minute intervals. Clicking on the **OK** button on this screen will close the screen down and return to the Chart Display screen.

The Refresh button -  - will refresh the screen's trend data if the screen is not in real-time mode.

The left-pointing green arrow button -  - will move the chart's view backward in time by the specified chart interval.

The chart interval button -  - will determine the number of hours displayed on the trend chart. The options are: **1 Hour, 2 Hours, 4 Hours, 8 Hours, 12 Hours, or 24 Hours.**

The right-pointing green arrow button -  - will move the chart's view forward in time by the specified chart interval.



The right-pointing arrow with the vertical line next to it button -  - will toggle between viewing the chart in or out of real-time. When in real-time mode, the chart will automatically be updated once a minute.

### Chart Sub Menu

There is a sub-menu available by putting a finger or a stylus anywhere on the chart and holding it there for a couple of seconds. The sub-menu will have the following options available: **Zoom**, **Restore**, **Add Note**, **Data**, and **Exit**.

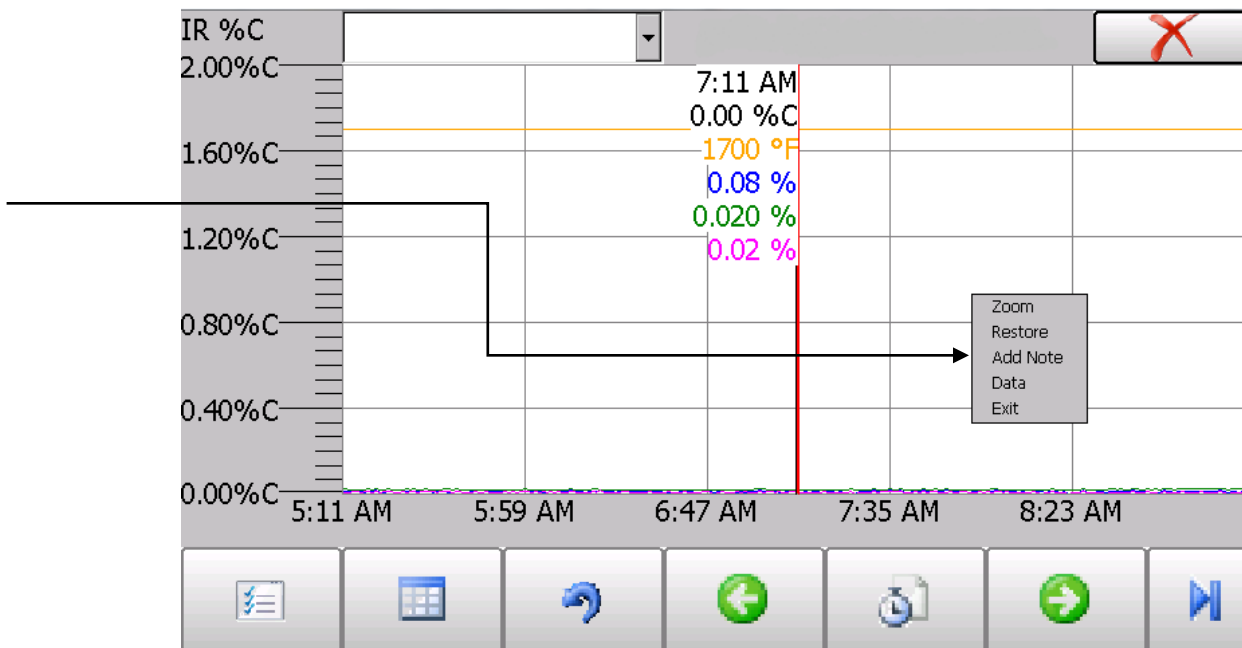

The **Zoom** option will allow the user to zoom in on a particular part of the screen. Once this has been selected, the user can take a stylus or a finger and create a box around the data. Once the user releases the stylus or finger, a zoom is no longer possible, and the user will need to re-select the option from the sub-menu to zoom in again.

The **Restore** option will back out of any zoom options that have been performed and display the initial chart screen.

The **Add Note** option allows the operator to enter a note on the chart, similar to writing on a paper chart. The note is available when the chart is printed out using the utility software included with the Series 9010 instrumentation. Pressing the **Add Note** option displays a screen where the operator can enter the operator ID or initials and a note. The user has the option to enter a note using either the operator interface keyboard and typing or using the Signature mode and writing the note with the stylus.

The **Data** option will show the trend data as a data grid instead of the trend lines on a chart. This

functionality is exactly the same as if the user pressed the Datagrid View button -  - from the chart screen.

**Exit** will close out the sub-menu without selecting an item.

Pressing the red 'X' in the top right-hand corner of the screen will take the user back to the status screen.

## Menu Lists

Accessing the menu screen will show three or four available options, depending on whether the Nitrider Calculation feature is installed.

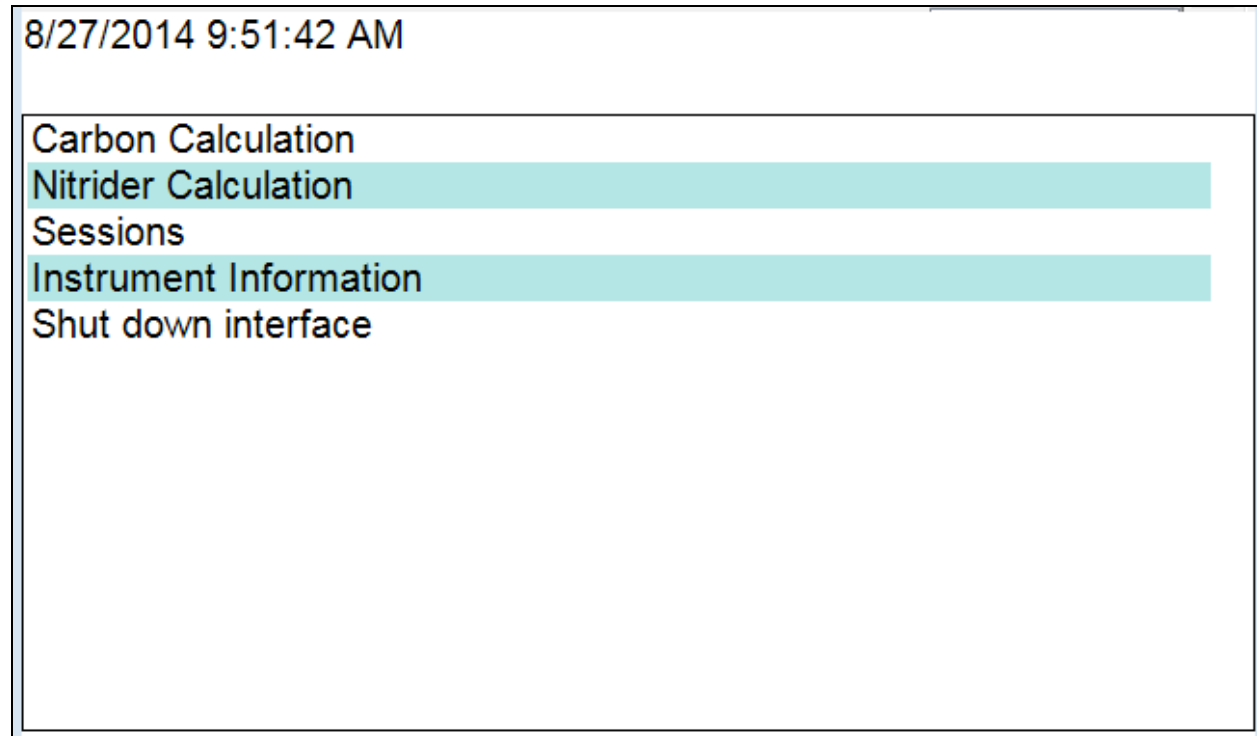

Carbon Calculation, Nitrider Calculation (if installed), Sessions, Instrument Information, and Shut Down Interface can be accessed by any users. Additional menu items are available when an authorized user logs in using an appropriate Pass Code. When the Supervisor Pass Code is entered (default = 1), the user will also be able to access the Pump Control and Instrument Information screen.

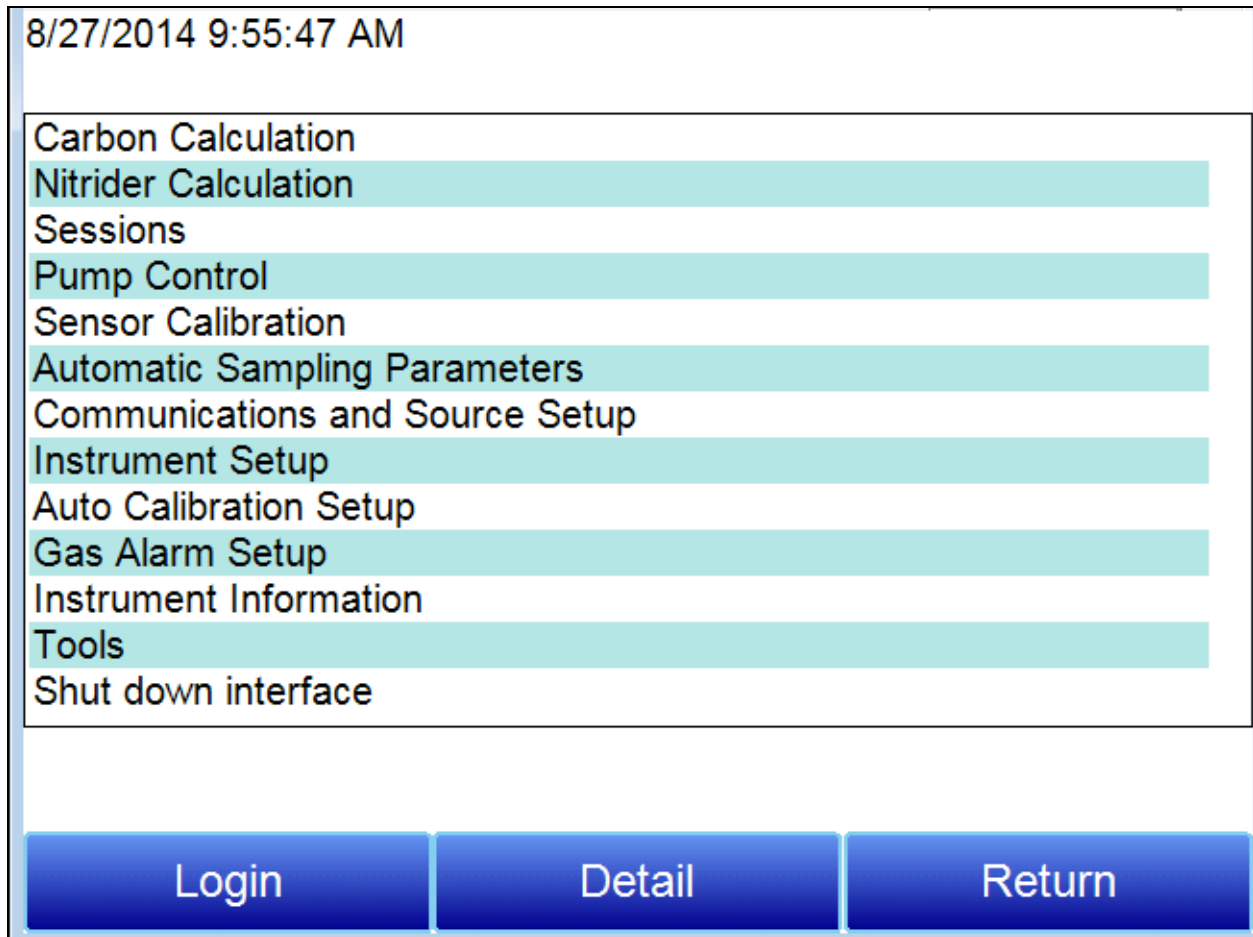

To see the full range of options available, the user must use the Configuration Pass Code (Default = 2). This provides the user with all available options including calibration and setup functions.

To access any items on the menu list, touch the item to highlight it and then press Detail. A specific description of each item on the list follows.

### Carbon Calculation

Please see the Carbon Calculation section starting on page 12.



## Nitrider Calculation (Available on Units Configured for Nitriding & FNC Applications)

When configured for nitriding and ferritic nitrocarburizing (FNC) applications, the MGA 6010 has the ability to provide a calculation of values essential those processes—specifically, nitriding potential ( $K_N$ ) and carburizing potential ( $K_C$ ). To access these values, open the Nitrider Calculation page. NOTE: If the MGA 6010 unit you are using does not have the Nitrider Calculation option, and you would like this feature added, please contact SSi at 513-772-0060.

Nitrider Calculation			
Furnace Temperature	1020 °F	H2	38.5%
Measured CO	5.00%	N2 Flow	750
Measured CO2	0.100%	NH3 Flow	750
Measured CH4	0.00%	DA Flow	0
		CO2 Flow	10
		Kn	2.04
		Kc	0.50
Pump Off	SESSION NOT ENABLED	COMMS: N/A	
	GAS: 90°F / INST.: 85°F	COF/PF ADJUST: N/A	
		Chart	Return

a

The Nitrider Calculation page displays data on current atmosphere parameters such as temperature and measured values for % CO, % CO<sub>2</sub>, % CH<sub>4</sub>, and % H<sub>2</sub> (if the H<sub>2</sub> sensor is installed). The calculated value for %C is also shown.

User-provided flow values for N<sub>2</sub>, NH<sub>3</sub>, DA, and CO<sub>2</sub> are used by the MGA 6010 in performing calculations. The flow values are visible on the right side of the Nitrider Calculation page. To change a flow value, simply tap on the blue field for that value. A numeric entry page will appear, allowing you to change the value. For the purpose of  $K_N$  and  $K_C$  calculations, any valid gas flow unit (for example, cubic feet per minute, or cfm) may be used. **The flow unit must be the same for all gases.** NOTE: If one or more of the flow gases do not show up in the list, it is likely that the gas flow valve is not enabled in the Tools → Valve Setup menu. Refer to the Valve Setup section on page 41 for more information.

$K_N$  provides a measurement of the amount of nitrogen that can be diffused into a metal (e.g., iron); it is a derived measurement based on the partial pressures of NH<sub>3</sub> and H<sub>2</sub>. The MGA 6010 performs the calculation of  $K_N$  using user-provided flow values and displays the calculated  $K_N$  value on the Nitrider Calculation page.

$K_C$  provides a measurement of the amount of carbon that can be diffused into a metal; it is derived from a calculation involving the partial pressures of  $CO_2$ ,  $H_2$ ,  $CO$ , and  $H_2O$ . The MGA 6010 performs the required calculation using user-provided flow values and displays the calculated  $K_C$  value on the Nitrider Calculation page.

NOTE: Calculation of  $K_C$  may have inaccuracies in the presence of ammonia.

### Sessions

The instrument is logging data any time that it is powered on. Data of interest can be viewed by entering its date and time. Users can apply custom tags to sections of data, allowing for easy identification of viewing and recalling data. These tags can include the name of the operator and the name of the equipment that is being measured.

The instrument has default values for each of these variables. However, it is highly recommended that the selections be modified so that data may be tagged in a way that is easily recognized. For more information on how to set up these selections with custom entries, see the "Tools – Database Maintenance" section of this manual.

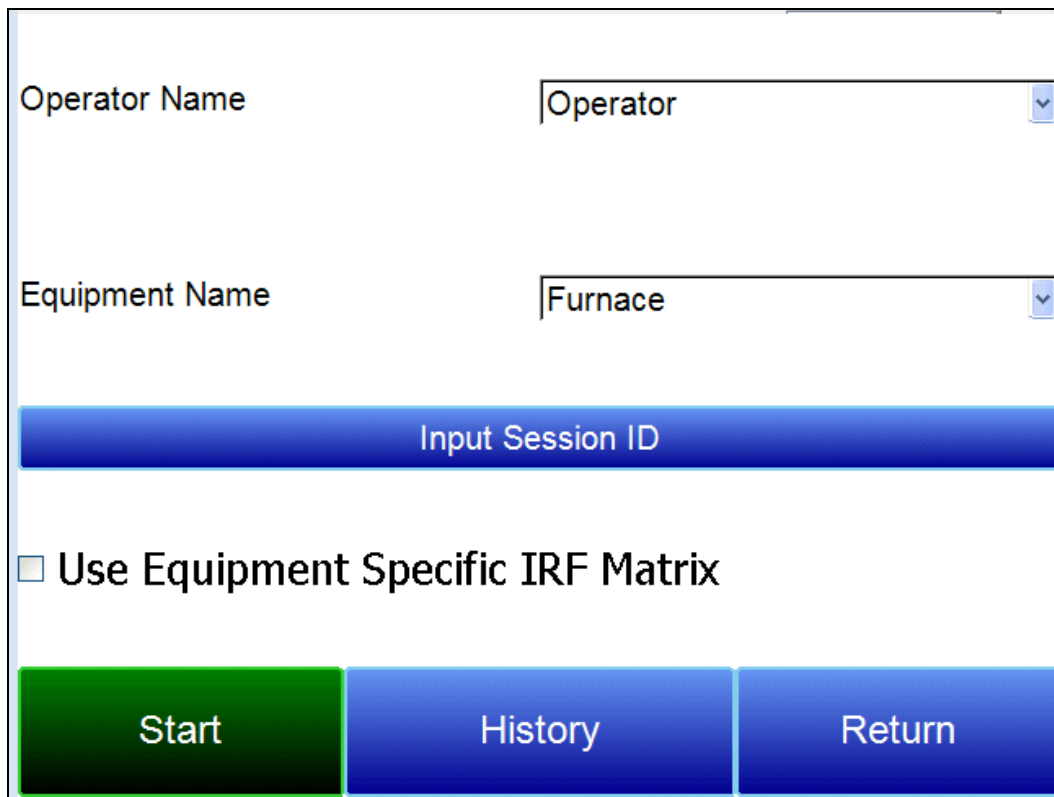

The screenshot shows a user interface for configuring a session. It includes two dropdown menus for selecting an operator and equipment. A button for entering a session ID is present, along with a checkbox for using an equipment-specific IRF matrix. At the bottom, there are three action buttons: Start, History, and Return.

Using the pull-down menus, select the **Operator Name** and **Equipment Name** from the list of available selections. If a Session ID is desired, tap on **Input Session ID** and use the text entry keyboard to enter a Session ID. If using an Equipment Specific IRF Matrix, make sure that the applicable checkbox is selected. (More information on the IRF Matrix can be found in the Calculation Factors section beginning on page 29.)

Begin the session by pressing **Start**. After confirming the beginning of a session, a sessions summary screen will be displayed. To end the session, press the red **End** button.

Display Sessions between		5/15/2011	and	6/18/2011
Start	End	Equipment	Operator	
6/16/2011 2:32:23 PM		502	Troy	
5/25/2011 8:27:11 AM	5/25/2011 1:16:22 PM	502	Troy	
5/19/2011 8:11:30 AM	5/19/2011 10:41:40 PM	1586 Lindberg	Troy	
5/18/2011 8:17:01 AM	5/18/2011 2:49:30 PM	1586 Lindberg	Troy	
5/17/2011 10:19:41 AM	5/17/2011 2:40:26 PM	1586 Lindberg	Troy	
5/16/2011 8:09:37 AM	5/16/2011 4:31:22 PM	1586 Lindberg	Troy	

End
Detail

Return

This screen will identify sessions within the date range specified at the top of the screen. As a default, sessions from the past 24 hours are shown. By expanding the data range, additional sessions can be seen. These sessions are sorted with the newest entry at the top, but they can be sorted by **End Time**, **Equipment Name**, or **Operator Name** by touching the header of each column. To see the details of any session, highlight it by touching it, and then press **Detail**. This will display a graphical representation of the data from the selected session.

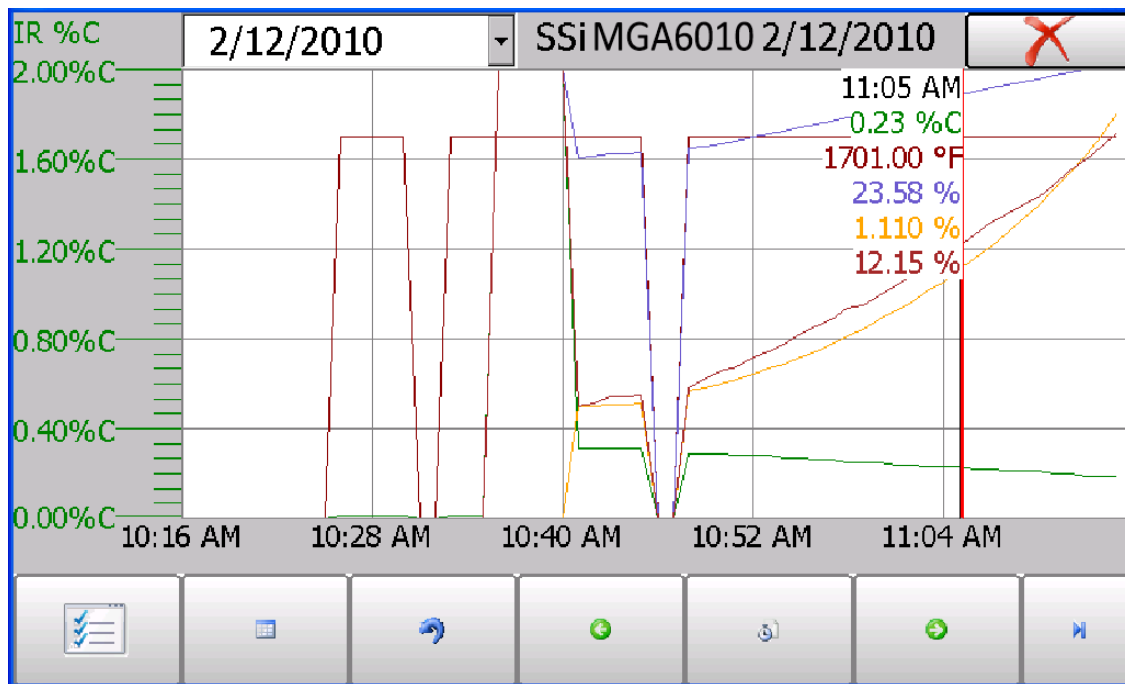

For more information on navigating the Chart Screen see the "Chart" section of this manual. To leave the Chart view, press the red X in the upper right hand corner of the screen.

## Pump Control

The Pump Control screen will identify and allow the modification of the pump status (**On** or **Off**), as well as the amount of time (in seconds) to delay turning the pump on (Pump On Delay) and off (Pump Off Delay).

Pump Control	
Pump Status	Off
Pump On Delay (seconds)	2
Pump Off Delay (seconds)	2

## Sensor Calibration

On the MGA 6010, you can perform a sensor calibration with one of four calibration sources. These sources are displayed when **Sensor Calibration** is first selected: **Automatic Calibration Port**, **Auxiliary Calibration Port**, **Sample Line (with pump on)**, and **Sample Line (with pump off)**.

Select Calibration Source	
<input checked="" type="radio"/>	Automatic Calibration Port
<input type="radio"/>	Auxiliary Calibration Port
<input type="radio"/>	Sample Line (with pump on)
<input type="radio"/>	Sample Line (with pump off)

You will be required to select one of the four sources.

With the **Automatic Calibration Port**, calibration is performed using the Zero Calibration Gas Inlet and Span Calibration Gas Inlet ports on the side of the unit.

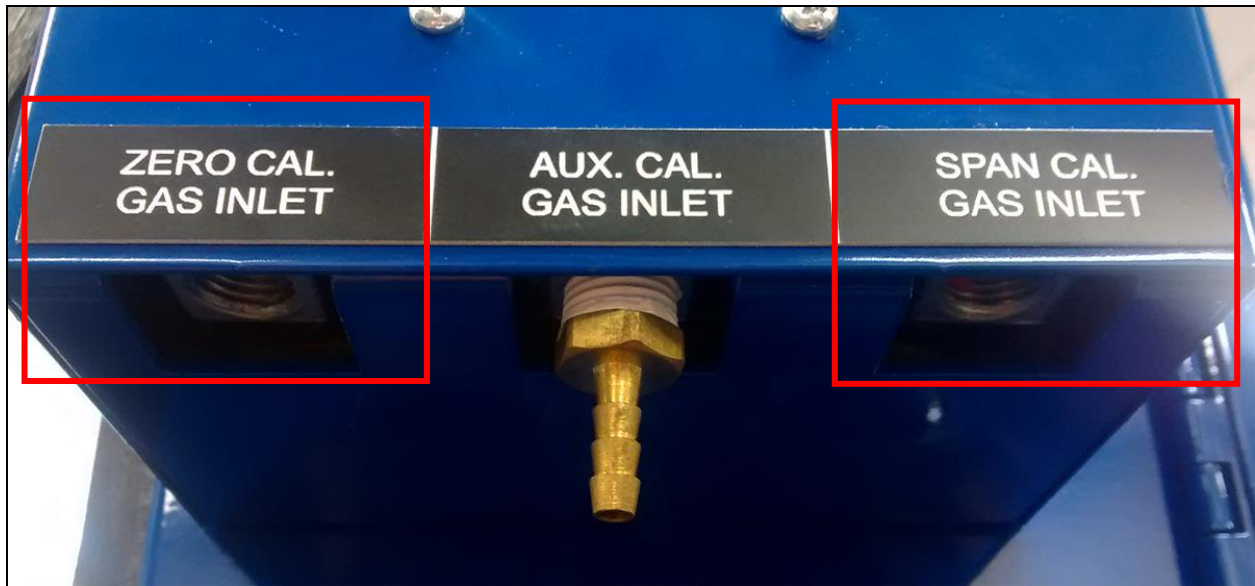

Gas Inlet Ports for Automatic Calibration

The **Auxiliary Calibration Port** makes use of the Auxiliary Calibration Gas Inlet, located on the side of the unit and in the middle of the gas inlets for Zero Calibration and Span Calibration. A single gas line is run to the Auxiliary Calibration Gas Inlet port for zero and span calibration.

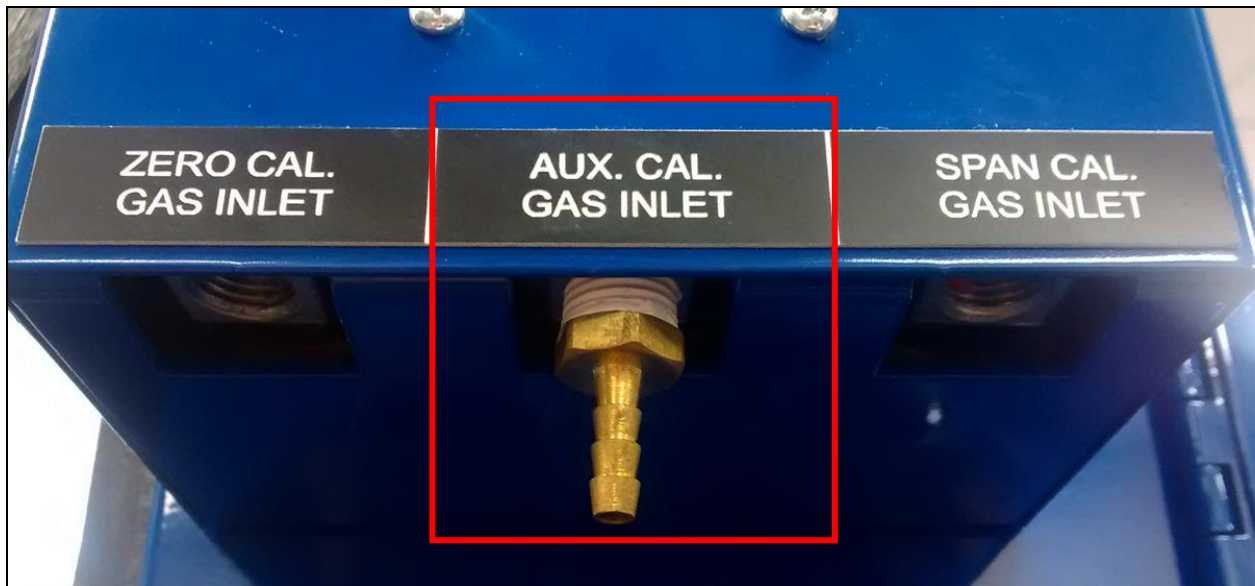

Gas Inlet Port for Auxiliary Calibration

Calibration with a **Sample Line** makes use of the Sample Inlet Port located on the side of the unit opposite the ports used for Automatic Calibration and Auxiliary Calibration. The option selected will depend on whether the pump is running [Sample Line (with pump on)] or not running [Sample Line (with pump off)].

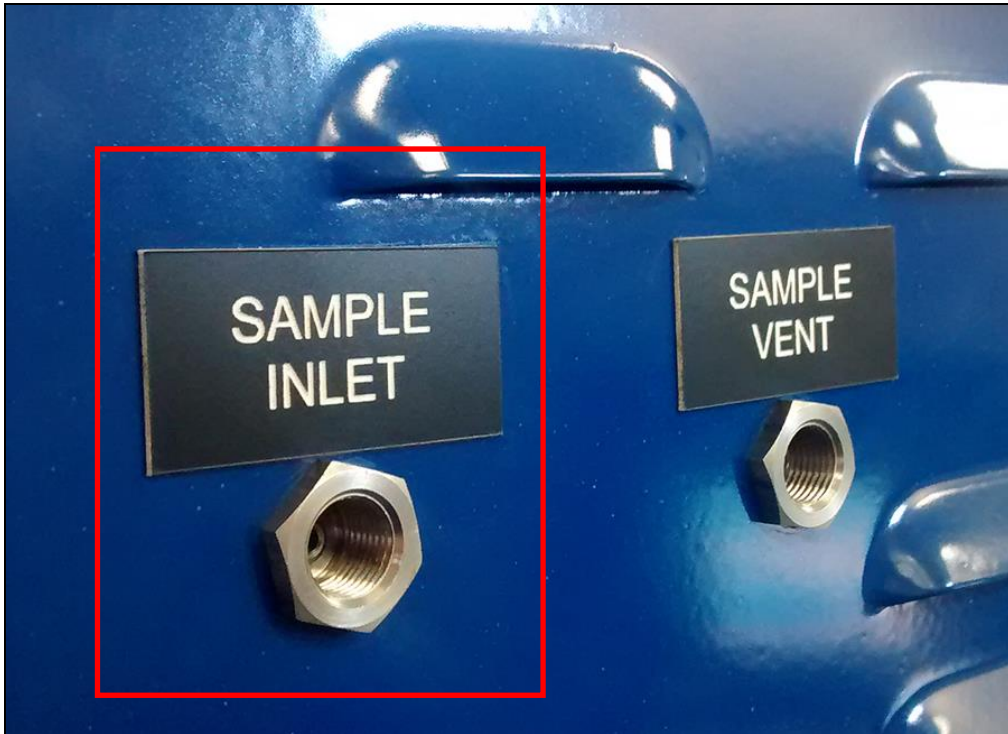

Sample Inlet Port Used for Sample Line Calibration

Once you have attached the gas line as needed and selected the desired calibration source, tap OK. A screen similar to the one shown below will be displayed.

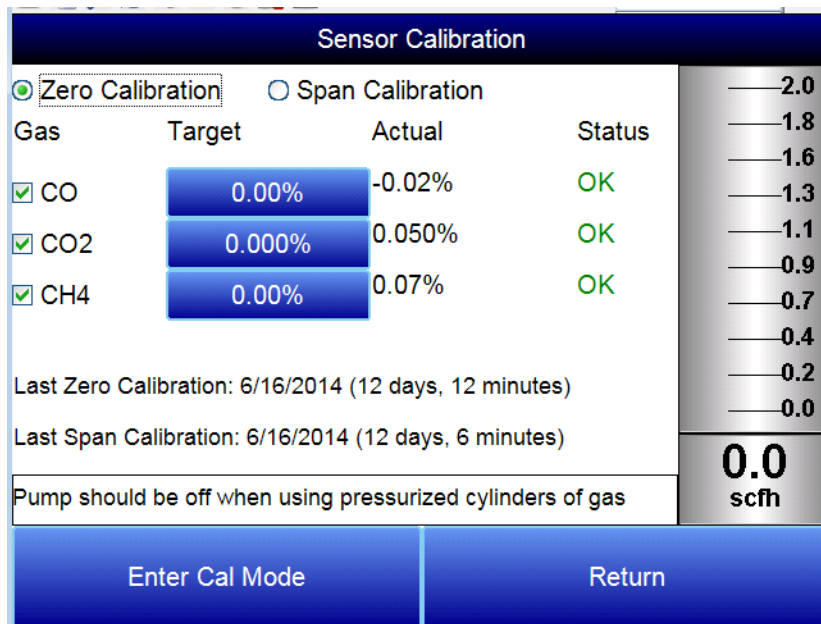

Two types of calibrations can be performed on the NDIR sensor: Zero and Span. The Zero calibration should be performed with a gas that has none of the measured gases in it. Ideally this would be pure Nitrogen or Argon. The concentration of the Span calibration gas should closely resemble the gas that is being measured. For a heat treating application measuring endothermic gas, the ideal composition would be:

- CO: 20%
- CO<sub>2</sub>: 0.5%
- CH<sub>4</sub>: 5.0%
- H<sub>2</sub>: 40%
- N<sub>2</sub>: Balance

Since the accuracy of the calibration gas directly influences the resulting accuracy of the instrument, the highest possible accuracy grade should be obtained. Some gas suppliers refer to this as a "Certified Primary Standard". The high degree of accuracy is not required to obtain nominal values that exactly match the values shown above. The accuracy is required to know the exact composition of the gas in the cylinder. The actual composition will be shown on the bottle when it is delivered.

When flowing calibration gas into the analyzer, turn the pump off. The amount of flow from the gas cylinder should be approximately 1.5 SCFH at no pressure. The gas cylinders will be under high pressure, so it is recommended that a two stage regulator with a low pressure secondary stage be used. It is good practice to begin the flow of gas before attaching the calibration gas to the instrument. This will prevent any high pressure bursts from entering the instrument.

Calibration gases can be obtained from Super Systems, however they can also be obtained from any supplier of custom gases.

#### **Hydrogen Cell Note:**

It is recommended that the instrument be turned on for three hours prior to performing an H<sub>2</sub> calibration.

#### Performing a Zero Calibration

From the Sensor Calibration screen, be sure that the button at the upper left of the instrument is selecting **Zero Calibration** and not **Span Calibration**.

When this is selected, the target values will automatically go to zero. Begin the flow of gas at the appropriate rate, and allow the readings to come to equilibrium. This occurs when the actual values are not moving in a specific direction, and they display only slight movements up and down. This should take approximately 45 seconds.

There is a column showing the Status of each gas. In this area the instrument is making a comparison between the Target value and the Actual value and providing feedback based on the amount of difference between the two. There are three possible words that can appear in this area:

"OK" – The gas is within 10% of where it is expected to be.

"OK?" – The gas is between 10% and 20% of where it is expected to be. This could indicate an issue with the calibration gas, so the calibration gas and the associated tubing should be checked and verified to be free from leaks or improper gas composition. This message does not necessarily indicate that there is a problem with the sensor or the calibration. It is meant only to have the operator make sure that the proper procedures are being followed.

"BAD" – The gas is more than 20% from where it is expected to be. The same items should be checked as described above. This message could indicate an issue with the sensor.

Regardless of the status of each of the gases, the instrument can be calibrated by waiting for the readings to stabilize and pressing **Start Calibration**. Timers will begin to count down, and when they reach zero the Actual values should be the same as the Target values (allowing for slight variations as a result of gas fluctuations).

### Performing a Span Calibration

A Span calibration is performed the similarly to the zero calibration but with two small changes. First, the selector button at the top should be on **Span Calibration** instead of **Zero Calibration**. Second, the gas values for the specific cylinder of gas being used need to be entered into the Target values. To do this, press the blue box associated with each gas and enter the value shown on the cylinder. For example, the nominal value for CO may be 20%, but your cylinder may actually have 19.96% CO. 19.96 is the value that should be entered as a Target.

After the gas values have been entered, proceed with the calibration in the same manner as with the zero calibration. Never perform a span calibration without first doing a zero calibration.

### Automatic Sampling Parameters

This instrument is capable of communicating directly with a control instrument. This is valuable because it will provide real-time entry of the temperature and millivolt information from the probe, allowing for an accurate comparison between the IR % Carbon and the Probe %Carbon. To establish this communications link, see "Communications and Source Setup – Atmosphere/ Temp Sources."

The Automatic Sampling Parameters screen will allow the user to adjust the way that the MGA 6010 updates the COF / PF in the atmosphere controller. All of the parameters on this page can be disregarded if the "COF/PF Adjustment Mode" is set to **Monitor** mode. These parameters only apply when the instrument is in **Control** mode.

Automatic Sampling Parameters	
COF/PF Adjustment Increment	1
COF/PF Adjustment Interval (minutes)	1
Minimum COF/PF Value	130
Maximum COF/PF Value	220
COF/PF Adjustment Mode	Monitor
Minimum Temperature for sampling	1490°F
Minimum Millivolts for sampling	1030 mV
Minimum Millivolt condition...	also stops pump
<div style="display: flex; justify-content: space-around; margin-top: 20px;"> <span>Edit</span> <span>Return</span> </div>	

#### COF/PF Adjustment Increment

When adjustments are made automatically, this value indicates the size of the step that is made when the COF/PF is changed. It is recommended that this number remain low to avoid making sudden changes to the process that could be caused by temporary conditions.



COF/PF Adjustment Interval (minutes)

This indicates the frequency that automatic adjustments are made. We recommend making small changes at a frequent interval instead of making large changes at longer intervals. This will prevent temporary changes in atmosphere from making dramatic adjustments to the COF/PF.

Minimum COF / PF Value

As a safeguard, the COF/PF can be prevented from dropping below a certain point. This point is the Minimum COF/PF value.

Maximum COF / PF Value

The Maximum COF/PF can also be entered as a safeguard.

COF / PF Adjustment Mode

This selection determines if changes to the COF/PF will be made automatically or if the instrument will monitor the conditions without making any changes. When in **Monitor** mode, a COF/PF will continue to be suggested, but no modifications will be made to the atmosphere controller.

Minimum Temperature for sampling (0 = disabled)

This value is the lowest temperature that the instrument will sample from. When the temperature drops below this value, the COF/PF adjustment will stop and the sample pump will turn off *only if the pump is set to "Auto" mode* (see the Pump Control section on page 20). To use this feature, the instrument should be communicating with an instrument that can provide real-time temperature data. The purpose of this function is to prevent the instrument from pulling a bad sample, which could potentially damage the sensors. The minimum temperature should always be slightly higher than the lowest possible process temperature.

Minimum Millivolts for sampling (0 = disabled)

This value is the lowest number of millivolts at which sampling will take place. When the number of millivolts drops below this value, the COF/PF adjustment will stop; the sample pump will turn off *only if the pump is set to "Auto" mode* (see the Pump Control section on page 20) and the Minimum Millivolt Condition is set to "Also stops pump" (see below). To use this feature, the instrument should be communicating with an instrument that can provide real-time probe millivolt data. The purpose of this function is to prevent the instrument from pulling a bad sample, which could potentially damage the sensors. This will prevent adjustments from being made when the proper conditions are not met. The minimum millivolts set point should be slightly higher than the minimum millivoltage that is expected.

Minimum Millivolt condition (0 = disabled)

This determines the behavior of the MGA 6010 when the minimum millivolts value is reached. Two settings are available:

- **Also stops pump.** When this setting is selected, the sample pump will be stopped *if the pump is set to "Auto" mode* (see the Pump Control section on page 20), and COF/PF adjustment will be stopped.
- **Only inhibits adjust and control.** When this setting is selected, COF/PF adjustment will be stopped, and the sample pump will be allowed to run.

To use this feature, the instrument should be communicating with an instrument that can provide real-time probe millivolt data. This is another feature that is intended to prevent the analyzer from pulling a bad sample and potentially damaging the sensors.

## Communications and Source Setup

This screen allows the user to view and modify the method of communications between the instrument and external devices.

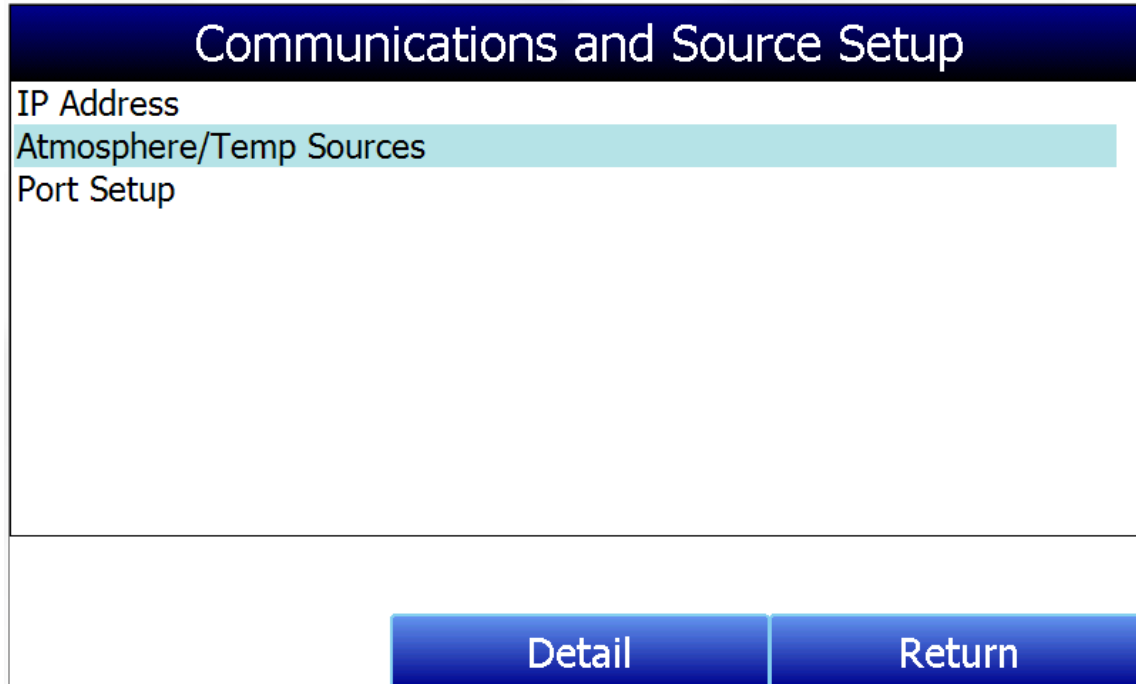

### IP Address

This section identifies the IP Address of the instrument. When connected to a network, the MGA 6010 screen will obtain its own IP Address. It does this during the power-up procedure, so if communication via Ethernet is preferred, plug the cable into the instrument before turning it on. To use a specific IP address, it must be entered on the Windows CE screen. This can only be accessed when the Gas Analyzer software has been shut down.

#### **Manually Setting the IP Address**

1. Log in to the MGA 6010 touch screen using the supervisor access code (by default, this code is '2').
2. Access the Instrument Setup → General Setup menu.
3. Select "Shut Down Software" followed by "Yes".
4. The program will shut down and a Windows CE screen will appear.
5. Click the Start menu in the lower left corner.
6. Select "Settings" and then "Network and Dial-up Connections".
7. Select "CS89001"
8. Select the option for "Specify an IP Address"
9. Enter the desired IP Address, Subnet Mask, and Default Gateway.
10. Select "OK"
11. Close open windows to return to the main Windows CE Screen.
12. Double-click on the "SaveRegs" icon.
13. Select "OK" from the Registry Save Complete notification.
14. Turn the instrument off and wait for the screen to turn off.
15. Turn the instrument back on.
16. The instrument will automatically boot up as a gas analyzer with the IP address that has been manually entered.

Atmosphere/Temp Sources

RS485 communications can be set up to automatically enter and update data from the oxygen probe and, if desired, make modifications to the COF/PF in the atmosphere controller.

Communications and Source Setup-Atmosphere/Temp Sources	
Port Usage	Modbus Master
Port Baud Rate	19200
Probe Temp/mV Instrument	SSI AC20
Probe Temp/mV Instrument Address	0
Status	Not configured
Furnace Temp Instrument	SSI 7EK
Furnace Temp Instrument Address	0
Status	Not configured
<div style="display: flex; justify-content: space-around; margin-top: 10px;"> <span>Edit</span> <span>Return</span> </div>	

*Port Usage*

This is the communication method used to supply information to the instrument. The possible values are:  
Modbus Master  
Modbus Host

*Port Baud Rate*

This is the speed of communications which can range between 1200 and 115200.

*Probe Temp/mV Instrument*

This is the make and model of the device that will be supplying the instrument with information on: probe temperature, probe millivolts, and COF/PF. Possible choices are:

- Internal, Probe mV, K
- Internal, Probe mV, S
- SSi AC20
- Yokogawa 750
- Honeywell UDC3300
- Dualpro 1 Mod
- Dualpro 2 Mod
- DP 1 MMI
- DP 2 MMI
- Eur 2404
- Eur 2500
- CP V3.5
- CP V3.0
- CarbPC
- SSi 9200 loop 1
- IR Base
- MGA
- 9010

*Probe Temp/mV Instrument Address*

This is the address of the atmosphere controller. It can be directly entered using the numeric keypad on the touch screen.

*Furnace Temp Instrument*

This is the make and model of the device that will be supplying the instrument with information on furnace temperature. If there is no instrument associated with this input, the probe temperature will be used. Possible selections are:

- |                       |                     |
|-----------------------|---------------------|
| Internal, S           | VC Base 3           |
| Internal, K           | VC Base 4           |
| SSi 7EK/804/808/816   | AIPC                |
| Yokogawa 750          | SSi 7SL             |
| Honeywell UDC 3300    | Flow Meter          |
| Dualpro 1 Mod         | UMC800              |
| Dualpro 2 Mod         | SSi D00             |
| DP 1 MMI              | SSi D01             |
| DP 2 MMI              | SSi D02             |
| Eur 2404              | SSi D03             |
| Eur 2500              | Yokogawa UT350      |
| UP V3.5               | Yokogawa 750 loop 2 |
| UP V3.0               | Yokogawa UP350      |
| CP3.5 SL              | DCP551              |
| CP3.0 SL              | Ascon 08            |
| 10Pro                 | Ascon X5            |
| DP IN C               | Ascon M4L           |
| SSi 9200 loop 1       | Ascon X5 Timer      |
| SSi 9200 loop 2       | SPUD                |
| SSi 9200 loop 3       | SSi AIB 3           |
| SSi 9100 loop 2       | Hydrogen            |
| Eurotherm 2704 loop 1 | Flow                |
| Eurotherm 2704 loop 2 | O2 remote           |
| Eurotherm 2704 loop 3 | Dual monitor        |
| VC Base 1             | Wflow               |
| VC Base 2             | 9010                |

*Furnace Temp Instrument Address*

This is the address of the furnace temperature instrument. It can be directly entered using the numeric keypad on the touch screen.

Port Setup

This page is used to set the parameters for the communications ports. The factory default settings are shown below, and they should not need to be changed by the operator.

Communications Setup-Port Setup	
Host Address	1
RS232 Port A Baud Rate	19200
RS232 Port A Mode	Modbus Master
RS485 Port C Baud Rate	19200
RS485 Port C Mode	Modbus
RS485 Port D Baud Rate	19200
RS485 Port D Mode	Modbus Master
<div style="display: flex; justify-content: space-around; margin-top: 10px;"> <span>Edit</span> <span>Return</span> </div>	

**Instrument Setup**

The items shown in this menu list are settings that should only need to be changed once. Any modifications to the default values will be saved in the instrument.

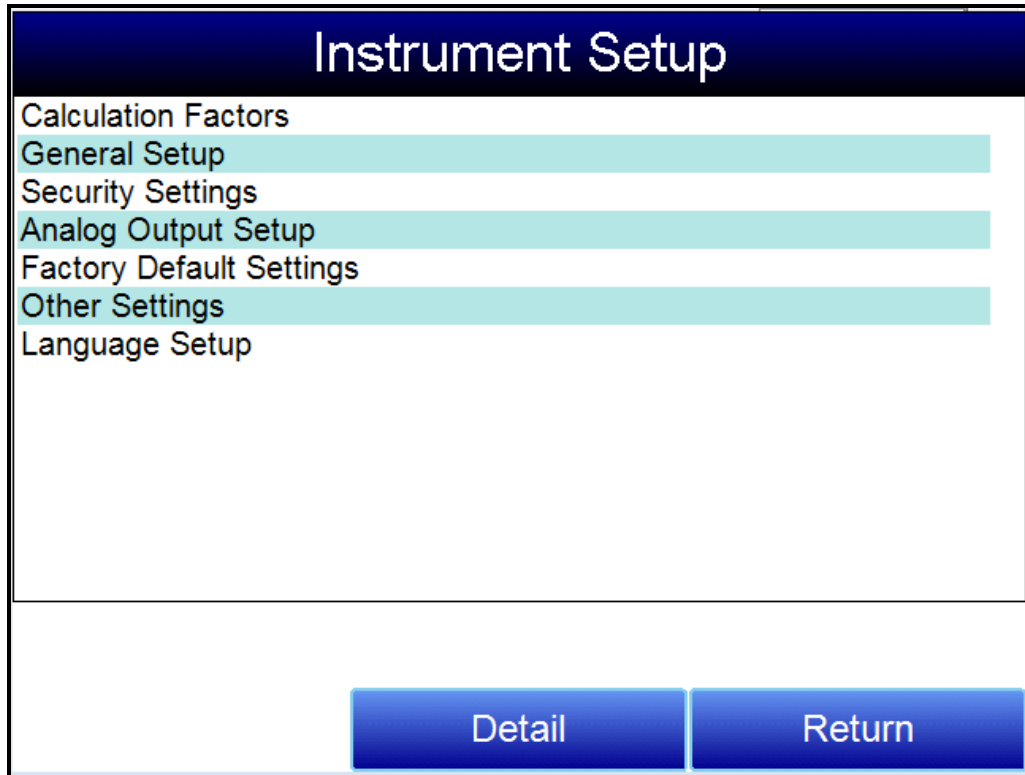

**Calculation Factors**

Instrument Setup-Calculation Factors	
IR Factor	CO Factor
IR Shim Factor	160
CH4 Factor	20
Current Working IR Factor	115
IRF Adjustment Matrix	
Use IRF Matrix	False
Equipment Specific IRF Matrices	
Set Setpoints based on IR Factor	
Use Furnace Temp for Furnace Se...	True

At the bottom of the table, there are two blue buttons: "Edit" on the left and "Return" on the right.

In this menu, there are two factors that will influence the calculation of carbon: **IR Shim Factor** and **CH<sub>4</sub> Factor**. Each of these factors is incorporated in the equation used to calculate %C; they are described in further detail below. The calculation factors should be changed only after determining that additional adjustments are required based on the specific conditions and equipment at each facility. Neither of them should be modified without significant testing or consultation from Super Systems, Inc.

#### *IR Factor*

This setting determines which of two parameters is incorporated in the %C calculation: **CO Factor** or **Process Factor (PF)**.

#### *IR Shim Factor*

Changing the IR Shim Factor is a way of modifying the computed percent carbon. The nominal value is 160. There is an inverse relationship between the IR Shim Factor and computed percent carbon. To increase the computed percent carbon, this number should be lowered, and to decrease the computed percent carbon it should be increased.

#### *CH<sub>4</sub> Factor*

This factor increases or decreases the significance of CH<sub>4</sub> in the calculation of carbon. CH<sub>4</sub> does not have a significant impact on the computed percent carbon, so it has a minor role in the equation. If the measured gas has over 5% CH<sub>4</sub>, its role in the equation may become greater than it should be. In these cases the CH<sub>4</sub> factor should be reduced. In cases where the CH<sub>4</sub> is present in excess of 7 or 8%, this factor can be reduced to zero.

#### *Current Working IR Factor*

This field shows the current IR Shim Factor adjustment value. It is not directly modifiable.

### ***Three Methods of %Carbon Calculation***

The MGA 6010 is able to calculate %Carbon using one of three methods: **Default Settings**, **IRF Matrix**, or **Equipment-Specific IRF Matrices**.

1. ***Default Settings***. This is the method used when **Use IRF Matrix** is set to False (off). The sample gas composition (%CO, %CO<sub>2</sub>, %CH<sub>4</sub>) and temperature, along with the programmed IR Shim Factor and CH<sub>4</sub> Factor, are used to arrive at a calculation of atmospheric %Carbon.
2. ***IRF Matrix***. When **Use IRF Matrix** is set to True (on), the MGA 6010 will use values configured in the **IRF Adjustment Matrix** to set the current IR Shim Factor. Configuring the adjustment matrix is described in more detail in the IRF Adjustment Matrix section below.
3. ***Equipment Specific IRF Matrices***. This method allows you to configure an IRF Matrix specific to a configured piece of equipment and change the calculation method based on the equipment whose gas composition is being analyzed. This method is described in more detail in the Equipment Specific IRF Matrices section below.

#### *IRF Adjustment Matrix*

The IRF Adjustment Matrix, sometimes referred to simply as the IRF Matrix, is used to set conditions under which the IR Shim Factor will be changed. Using the IRF Matrix, a total of 16 different IR Shim Factors can be configured if both temperature and atmosphere are considered; a total of 4 different IR Shim Factors can be configured if only temperature is considered. **NOTE: Use IRF Matrix** must be set to "True" for this function to be used.

IRF Adjustment Matrix	
Temp Only	No
Atmosphere Limit	0.25
Atmosphere Limit	0.4
Atmosphere Limit	0.6
Temperature Limit	1200
Temperature Limit	1400
Temperature Limit	1600
IRF (Atm < 0.25, Temp < 1200)	95
IRF (Atm < 0.25, 1200 <= Temp < 1400)	105
IRF (Atm < 0.25, 1400 <= Temp < 1600)	115
IRF (Atm < 0.25, 1600 <= Temp)	125

Edit
Return

The following steps describe how to configure the IRF Matrix.

- To begin, decide whether both atmosphere and temperature should be considered in setting the IR Shim Factor, or only temperature.
  - If both atmosphere and temperature apply, set **Temp Only** to "No" (and then go to step 2 below).
  - If only temperature applies, set **Temp Only** to "Yes" (and then go to step 3 below).

- Configure up to 3 atmosphere limits. Each atmosphere limit marks a boundary line within the matrix. Atmosphere values above and below each limit will be evaluated in determining the IR Shim Factor.

For example, if the atmosphere limits are 0.25, 0.4, and 0.6, the following ranges will be evaluated in helping to determine the IR Shim Factor:

- Less than 0.25 (Atm < 0.25)
- 0.25 – 0.39 (0.25 <= Atm < 0.4)
- 0.4 – 0.59 (0.4 <= Atm < 0.6)
- 0.6 and higher (0.6 <= Atm)

- Configure up to 3 temperature limits. Each temperature limit marks a boundary line within the matrix. Temperature values above and below each limit will be evaluated in determining the IR Shim Factor.

For example, if the temperature limits are 1200, 1400, and 1600, the following ranges will be evaluated in helping to determine the IR Shim Factor:

- Less than 1200 (Temp < 1200)
- 1200 - 1399 (1200 <= Temp < 1400)
- 1400 - 1599 (1400 <= Temp < 1600)
- 1600 and higher (1600 <= Temp)

- Now, enter an IR Shim Factor for each set of ranges. Do this by tapping on a set of ranges and then tapping "Edit". A numeric entry screen will appear, allowing you to enter a value for the IR Shim Factor.

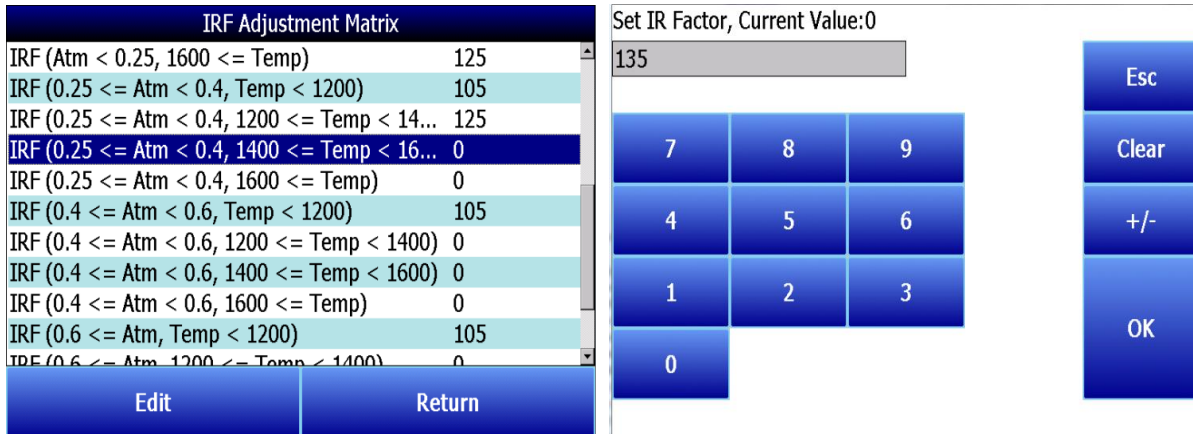

Once IR Shim Factor values have been entered for each set of ranges, the IRF Matrix is configured. The IRF Shim Factor will be set to the configured value for a set of ranges when the atmosphere and temperature (or temperature only, if configured that way) are within those respective ranges. For example, if the atmosphere is 0.3% and the temperature is 1230°, and the IRF for range set [0.25 <= Atm < 0.4, 1200 <= Temp < 1400] is 125, the MGA 6010 will set the current IR Shim Factor to 125.

Click **Return** to return to the Calculation Factors screen.

*Use IRF Matrix*

This setting determines whether or not the IRF Adjustment Matrix is used to set the IR Shim Factor. There are two possible settings: **False** (default) and **True**. If Use IRF Matrix is set to False, the IRF Adjustment Matrix will not be used (and Default Settings will be applied). If Use IRF Matrix is set to True, the IRF Adjustment Matrix will be applied to the IR Shim Factor.

*Equipment Specific IRF Matrices*

The MGA 6010 can be set up to use different IRF Adjustment Matrices based on the specific equipment whose gas composition is being analyzed. To use this feature, follow the steps below. **NOTE:** This procedure requires administrator access (default login: '2').

1. Make sure that the piece of equipment for which you want to set up an IRF Adjustment Matrix is configured in the Tools → Database Maintenance → Maintain Equipment menu. If the equipment has not been added, you will need to add it. Remember that Equipment is tied to Equipment Types; therefore, you may need to add an Equipment Type in the Tools → Database Maintenance → Maintain Equipment Type menu first.

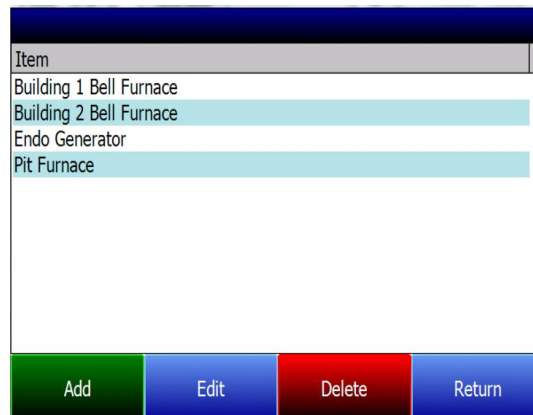



- Open the Instrument Setup → Calculation Factors menu.

Instrument Setup-Calculation Factors	
IR Factor	CO Factor
IR Shim Factor	115
CH4 Factor	20
Current Working IR Factor	115
IRF Adjustment Matrix	True
Use IRF Matrix	False
Equipment Specific IRF Matrices	
Set Setpoints based on IR Factor	
Use Furnace Temp for Furnace Se...	True

Edit Return

- Open the Equipment Specific IRF Matrices menu option. Select the equipment for which you want to set up an IRF Matrix. Then click **Edit**.

Select Equipment
Building 1 Bell Furnace
Building 2 Bell Furnace
Endo Generator
Pit Furnace

Edit Return

- IRF Matrix parameters for the selected equipment will be displayed. Edit the parameters for the equipment. Parameters are described in the IRF Adjustment Matrix section above.

Building 1 Bell Furnace IRF Adjustment Matrix	
Temp Only	No
Atmosphere Limit	0.5
Atmosphere Limit	1
Atmosphere Limit	2
Temperature Limit	1000
Temperature Limit	1500
Temperature Limit	2000
IRF (Atm < 0.5, Temp < 1000)	180
IRF (Atm < 0.5, 1000 <= Temp < 1500)	180
IRF (Atm < 0.5, 1500 <= Temp < 2000)	180

Edit Save Cancel

- Click **Save** when finished editing parameters. The IRF Matrix for this particular equipment is now set up.

**When ready to start a Session for this piece of equipment:**

- Open the Sessions menu from the main MGA 6010 menu.
- Using the **Equipment Name** drop-down box, select the piece of equipment for which you want to apply an Equipment Specific IRF Matrix.
- Make sure that the **Use Equipment Specific IRF Matrix** box is checked.
- Press **Start** to begin the Session.

Operator Name	<input type="text" value="Operator"/>
Equipment Name	<input type="text" value="Building 1 Bell Furnace"/>
Input Session ID	
<input checked="" type="checkbox"/> Use Equipment Specific IRF Matrix	
<span>Start</span>	<span>History</span> <span>Return</span>

*Set Setpoints based on IR Factor*

The MGA 6010 has the ability to automatically adjust temperature and atmosphere setpoint in an effort to get the Process Variables (PVs) for temperature and atmosphere within a selected range set in the IRF Matrix. This option allows you to select an IRF Matrix range set based on which the MGA 6010 will make adjustments to temperature and atmosphere setpoints. Of course, if the IRF Matrix is configured so that only temperature is used in determining changes to the IR Shim Factor, only temperature will be displayed in the menu for **Set Setpoints based on IR Factor**, and only the temperature setpoint will be adjusted by the MGA 6010 when this option is used. Note that **Use IRF Matrix** and **Use Furnace Temp for Furnace Setpoint** must both be set to "True" for this option to work. In addition, the MGA 6010 must not be configured to communicate with slave instruments; see the **IMPORTANT!** box below.

IRF Adjustment Matrix	
IRF (Atm < 0.25, Temp < 1200)	95
IRF (Atm < 0.25, 1200 <= Temp < 1400)	105
IRF (Atm < 0.25, 1400 <= Temp < 1600)	115
IRF (Atm < 0.25, 1600 <= Temp)	125
IRF (0.25 <= Atm < 0.4, Temp < 1200)	135
IRF (0.25 <= Atm < 0.4, 1200 <= Temp < 1400)	125
IRF (0.25 <= Atm < 0.4, 1400 <= Temp < 1600)	125
IRF (0.25 <= Atm < 0.4, 1600 <= Temp)	125
IRF (0.4 <= Atm < 0.6, Temp < 1200)	105
IRF (0.4 <= Atm < 0.6, 1200 <= Temp < 1400)	95
IRF (0.4 <= Atm < 0.6, 1400 <= Temp < 1600)	95

Select Input
Return

An example of how this option is used can be given as follows. Assume that, in the IRF Matrix, one of the range sets is (0.25 <= Atm < 0.4, Temp < 1200) with a corresponding IR Shim Factor of 135. Because this range set is set up in the IRF Matrix, it will appear as an option in the **Set Setpoints based on IR Factor** selection list. To apply this range set to the atmosphere and temperature setpoints, the user first taps on the **IRF (0.25 <= Atm < 0.4, Temp < 1200) 135** line in the menu list until that option is highlighted. Next, the user taps on the **Select Input** button to apply that option.

Once the range set is selected and applied, the MGA 6010 will automatically change the temperature setpoint and (if applicable) atmosphere setpoint. In the **Carbon Calculation** screen, the **Temperature Setpoint** and **Carbon Setpoint** will not be visible or editable while control is based on IR Factor.

**IMPORTANT!**

This option will work only when the MGA 6010 is not communicating with any slave instruments. If you attempt to use this option by tapping it and then tapping "Edit" when the MGA 6010 is communicating with a slave instrument, the message "Cannot use this feature with Slave Instrument configured" will be displayed. To disable slave instruments, open the Communications and Source Setup → Atmosphere/Temp Sources menu; then set both the **Probe Temp/mV Instrument Address** and **Furnace Temp Instrument Address** to "0".

Communications and Source Setup-Atmosphere/Temp Sources	
Port Usage	Modbus Master
Port Baud Rate	19200
Probe Temp/mV Instrument	SST AC20
Probe Temp/mV Instrument Address	0
Status	Not configured
Furnace Temp Instrument	SST 7FK
Furnace Temp Instrument Address	0
Status	Not configured
<div style="display: flex; justify-content: space-around; margin-top: 10px;"> <span>Edit</span> <span>Return</span> </div>	

*Use Furnace Temp for Furnace Setpoint*

When this option is set to "True", the MGA 6010 will use the furnace temperature as the value used to select an IR Shim Factor. When this option is set to "False", the MGA 6010 will use the temperature setpoint as the value used to select the IR Shim Factor.

General Setup

This screen shows the current time and date for the instrument, as well as the temperature scale. The temperature mode can be changed from this screen, but the time cannot be changed unless the MGA software is closed. This can be done through the following steps:

Manually Setting the Time, Date, and Time Zone

1. Log in to the MGA 6010 touch screen using the supervisor access code (by default, this code is '2').
2. Access the Instrument Setup → General Setup menu.
3. Select "Shut Down Software" followed by "Yes".
4. The program will shut down and a Windows CE screen will appear.
5. Click the time in the lower right corner (press the stylus in this corner if the time does not automatically appear).
6. Set the time, date, and time zone to the desired settings
7. Select "OK"
8. Double-click on the "SaveRegs" icon.
9. Select "OK" from the Registry Save Complete notification.
10. Turn the instrument off and wait for the screen to turn off.
11. Turn the instrument back on.
12. The instrument will automatically boot up as a gas analyzer with the IP address that has been manually entered.

**NOTE:** If touch screen is recording data with date and time information that is "shifted" from that displayed in the external datalogging software (e.g., readings at 9am are displayed as 11am), then the time zone and daylight savings settings *on the external computer* may need to be adjusted, in addition to performing the procedure above.

Security Settings

This page is used to change the pass code used for logging into the menu list. The default setting for the Supervisor Pass Code is 1, and the default setting for Configuration is 2. The maximum value for either code is 32767.

The Configuration Code will also work for all items on the Supervisor Pass Code items, so entering the Configuration Code (default =2) will provide access to all available menus.

### Analog Output Setup

The MGA 6010 has four analog outputs. These outputs can be configured for variable, zero value, and span value. The **Variable** is the process variable that applies to that analog output. Possible values are **CO, CO<sub>2</sub>, H<sub>2</sub>, High CO<sub>2</sub>, IR % carbon, Gas ratio, and Gas squared ratio**. The **Zero Value** is the value that corresponds to 4mA on a 4-20mA scale. The **Span Value** is the value that corresponds to 20mA on a 4-20mA scale.

Instrument Setup-Analog Output Setup	
Analog Output #1 Variable	CO
Analog Output #1 Zero Value	0.00
Analog Output #1 Span Value	30.00
Analog Output #2 Variable	CO2
Analog Output #2 Zero Value	0.000
Analog Output #2 Span Value	2.000
Analog Output #3 Variable	CH4
Analog Output #3 Zero Value	0.00
Analog Output #3 Span Value	30.00
Analog Output #4 Variable	IR_percent_carbon
Analog Output #4 Zero Value	0.00
Analog Output #4 Span Value	2.00
<div style="display: flex; justify-content: space-around; margin-top: 10px;"> <span>Edit</span> <span>Return</span> </div>	

### Factory Default Settings

Selecting this option will cause the instrument to revert back to the settings that it contained when it came from Super Systems. Any changes or modifications made since then will be lost.

### Other Settings

This screen displays calculated dew point. This value is not normally displayed because it is only accurate during certain conditions. Calculating dew point by using the gas values requires assumptions to be made regarding the composition of the gas being sampled. Since these assumptions are not always accurate the resulting dew point is not always accurate. When using Endothermic gas in a heat treating environment, the calculated dew point will usually be close to the correct value, but there is no substitute for a dew point that is determined through direct measurement of the moisture content of the gas.

When the dew point is enabled, it will appear near the bottom left of the Carbon Calculation screen.

### Language Setup

The instrument language should be pre-configured at Super Systems prior to shipment but can also be changed by making a selection from the drop-down list. For the language change to take effect, the instrument must be powered off and then back on again.

Auto Calibration Setup

Auto Calibration Setup	
Auto Calibration	No
Calibration Purge (sec)	90
Zero Interval (hours)	48
Calibration Interval (hours)	96
<input type="button" value="Zero Calibration"/> <input type="button" value="Span Calibration"/> <input type="button" value="Zero and Span Calibration"/>	
<input type="button" value="Return"/>	

The automatic calibration feature allows the instrument to calibrate itself using external supplies of zero and span calibration gases at pre-determined intervals or events as dictated by the user. The first step when setting up the automatic calibration feature on the MGA 6010 is to connect the Zero and Span calibration gases to the appropriate ports on the left side of the enclosure. There are blocking solenoids at each of these ports to only allow the flow of gas when it is called for and to prevent the flow when not needed. The pressure in the gas lines will need to be adjusted to maintain a flow rate similar to the sample flow rate, which should be between 20 and 50psi.

**Method #1: Automatic calibrations based on timed intervals**

The interval between calibrations is determined on the Auto Calibration Setup screen. Auto Calibration must be set to "On". The calibration purge timer allows for the flow of calibration gas to purge the sample gas from the instrument before performing a calibration. If the sample lines are long the time can be increased from the default value of 90 seconds.

The zero and span intervals are measured in hours. The appropriate interval can be based on the process and the desired degree of accuracy. The standard values are 48 hours for a zero calibration and 96 hours for a span calibration.

**Method #2: Automatic calibration based on digital inputs**

It is also possible to initiate calibrations externally. This method may be beneficial if the calibration is to be tied in with a process event or as directed by a PLC. Connecting Terminals 3681 and the adjacent 1080 terminal will initiate an automatic Zero calibration. Connecting Terminals 3661 and the adjacent 1080 terminal will initiate an automatic Span calibration. Calibration can be initiated using the digital inputs regardless of the timed interval calibration setup. There are no setups required for the digital inputs since they are not user-configurable.

The three buttons at the bottom of the screen (Zero Calibration, Span Calibration, Zero and Span Calibration), can be used to initiate immediate calibrations from the Auto Calibration Setup screen. These buttons will not work unless the automatic calibration feature has been enabled.

Gas Alarm Setup

Gas Alarm Setup			
Parameter	Lower Limit	Upper Limit	Action
CO	none	none	none
CO2	none	none	none
CH4	none	none	none
H2	none	none	none
O2	none	none	none
CO2	none	none	none
IR %C	none	none	none
CO/CO2	none	none	none
CO <sup>2</sup> /CO2	none	none	none
Furnace Temp...	none	none	none
Probe TC	none	none	none
Probe mV	none	none	none
Probe CO Fac...	none	none	none
Probe %C	none	none	none

Edit
Return

The MGA 6010 allows the user to configure various alarms. For each parameter, the Lower Limit, Upper Limit, and Action. As default, no alarms are enabled on the MGA unless a special request was made to do so at the time of ordering. To modify a parameter, select the item and press Edit. A screen will appear allow for the entry of the limits and the action. When any parameter is in an alarm state, a notification banner will show at the top of the screen identifying the alarm, and the red light on the door will illuminate. If desired, one of the two relays (or both simultaneously) can be energized. There are four possible actions for the alarms:

- **None** – On screen notification of alarm condition. No relay actions.
- **AL1** – On screen notification of alarm condition plus energizing of alarm relay #1.
- **AL2** – On screen notification of alarm condition plus energizing of alarm relay #2.
- **AL1 & AL2** – On screen notification of alarm condition plus energizing of alarm relays #1 and #2.

The relays provide a contact that can be connected to external lights, horns, or other devices as desired. The rating for these relay contacts is maximum of 6 Amps / 250 Volts.

Instrument Information

These items cannot be modified; they can only be viewed.

General Information

This is information on the revision levels of various components of the instrument. This can be valuable when consulting with Super Systems about issues with the instrument.

Calibration Dates

This area describes the last time the instrument was calibrated at Super Systems, plus any calibrations that have been performed since then. These dates and times are automatically computed and cannot be manually entered.

Power Status

This screen will identify the amount of voltage that is available to the instrument.

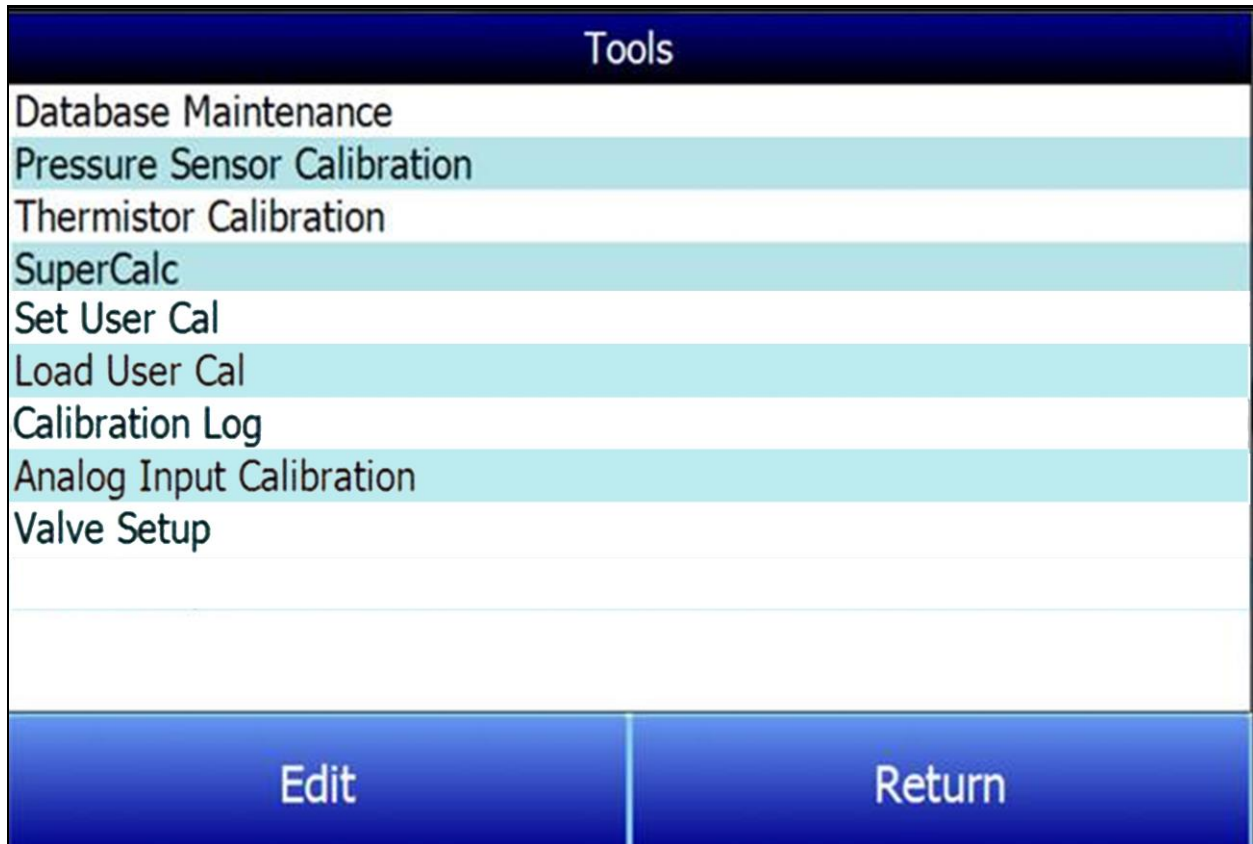
ToolsDatabase Maintenance

To make the information recorded during a Session more valuable, the Sessions database should be populated with relevant information regarding the people who will be using the instrument and the equipment that they will be working on. Taking the time to enter this information will provide additional fields to sort by after the data has been collected in a session.

*Maintain Equipment Types*

Many of the common types of heat treating equipment have been added into the MGA 6010 as default entries. This screen allows irrelevant items to be removed and additional items to be added.

*Maintain Equipment*

Each organization has different names for the various pieces of equipment in their shop. Those names should be entered here. Each name needs to be associated with a specific Equipment Type, so that database should be populated first.

### *Maintain Sessions*

The MGA 6010 is designed to delete the oldest files first in the event that the storage capacity has been exceeded. It is also possible to delete old files manually by entering a date on this screen. All files that were made before that date would be permanently deleted. It is important to note that after the data has been downloaded to a computer, a copy is stored on that computer. The data will always be available on the computer even if it has been deleted from the screen.

### *Maintain Users*

The names of all potential users can be entered here. Names can be added and deleted as required.

### *Compact Database*

Periodic database compaction will help make data storage more efficient and allow more data to be stored before it is automatically deleted. Nothing is deleted or lost when this button is pressed, and the only result will be a performance improvement.

### *Repair Database*

Use this option to repair an existing database when and if you suspect there are errors to the existing database.

### Pressure Sensor Calibration

The pressure is set at Super Systems for local conditions. For optimal performance, the ambient pressure should be reset at the final destination. This can be done by determining the barometric pressure and the elevation and entering them on this screen. After the two values have been entered, press the **Calibrate** button and the pressure sensor calibration will be complete.

### Thermister Calibration

This will be set at Super Systems and should not need to be adjusted by the end user. It allows for the sample gas temperature and the ambient temperature inside the instrument to be set. This should only be performed after the instrument has been powered on long enough for it to achieve temperature equilibrium.

### SuperCalc

SuperCalc is a proprietary software tool developed by SSI to allow the user to perform different scenarios and view the resulting percent carbon. It allows the user to enter gas percentages, probe information, and temperatures to see the effects of each variable on the calculated percent carbon. The data on this screen is independent of any values that are determined by the MGA 6010, and it is only provided as a reference tool.

### Set User Cal / Load User Cal

This feature allows the user to create new factory default calibration settings for the sensor. Instead of reverting to the factory calibration values, it can revert back to different calibration settings. This is accomplished by first setting the user calibration values. At any time after they are set, they can be restored by selecting Load User Cal.



## Valve Setup

The MGA 6010 uses four flow control valves for nitriding gas analysis. These valves are enabled and set up in the Valve Setup window.

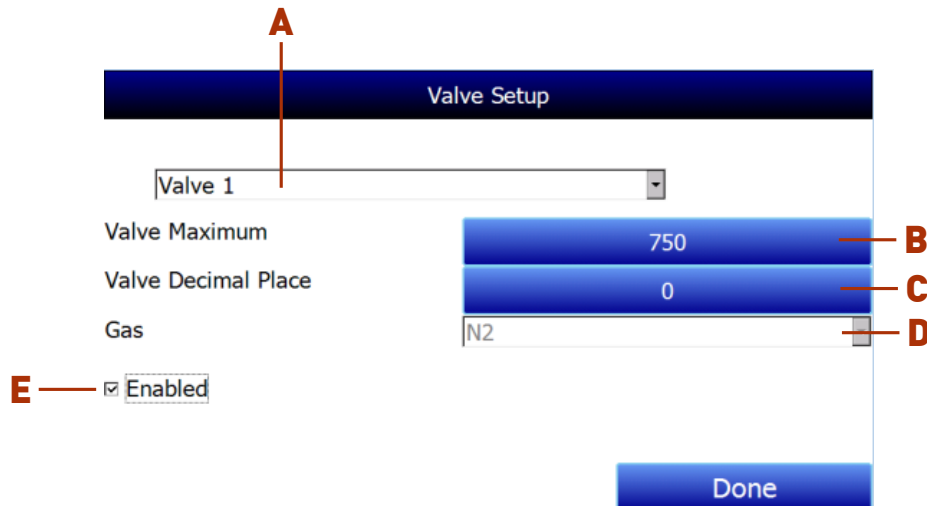

The Valve Setup window contains the following items:

**A – Valve Selection Drop-Down List.** Using this drop-down list, you can select the valve number (1 through 4) that you want to configure.

**B – Valve Maximum.** This field is used to set the maximum valve that can be entered for the valve gas flow. Tap on the field to change it.

**C – Valve Decimal Place.** This field is used to set the number of decimal places that will be used in the valve gas flow value in the Nitrider Calculation page. For example, if the valve decimal place is set to “1” in this menu, and “600” is entered for valve 1 flow on the Nitrider Calculation page, the displayed value will be “60.0”. **NOTE:** This field will also change the number of decimal places used for the Valve Maximum field in the Valve Setup menu.

**D – Gas Selection Drop-Down List.** This drop-down list allows you to select the gas used in the selected flow control valve. If used, valve 1 must be used with N<sub>2</sub>, and valve 2 must be used with NH<sub>3</sub> (these are fixed). Valve 3 may be used with Dissociated Ammonia (DA), NH<sub>3</sub>, a miscellaneous gas (Misc), endothermic gas (Endo), or CO<sub>2</sub>. Valve 4 may be used with H<sub>2</sub>, NH<sub>3</sub>, a miscellaneous gas (Misc), endothermic gas (Endo), or CO<sub>2</sub>.

**E – “Enabled” checkbox.** If this box is checked, the selected flow control valve number is enabled and will be displayed on the Nitrider Calculation page. If it is not checked, the valve is disabled; it will not be displayed on the Nitrider Calculation page.

When finished with valve setup, tap the “Done” button.

## Shut Down Interface

Use this option to shut down the touch screen interface for the MGA 6010. **It is recommended that you not shut down the screen interface unless you are following technical support instructions from SSI or you are preparing to power down the MGA 6010 unit.**

## Parts List and Internal Components

The following items can be purchased as needed for the MGA 6010.

Part Number	Description
37051	Bowl Filter Element
20264	Ceramic Lined Sample Tubing Assembly with High Temperature Filter
13504	Span Gas Blend, 90 cubic feet, including cylinder and regulator assembly
13505	Zero Gas (Nitrogen), 90 cubic feet, including cylinder and regulator assembly
32126	Relay, SPDT
37198	Sample solenoid (Stainless Steel)
37199	Calibration gas blocking solenoid (Brass)
20866	IR Sensor
20624	H2 Sensor
13709	Matrix Module Digital I/O Combo
13702	Matrix Module Analog 4-Output
31274	Color touch screen
31295	Touch Screen Stylus
31135	24VDC power supply
37177	Sample Pump, 110VAC
37177.22	Sample Pump, 220VAC
<b>Full MGA 6010 Units</b>	
13580	Standard 3-Gas MGA 6010 [CO, CO <sub>2</sub> , & CH <sub>4</sub> ]
13581	4-Gas MGA 6010 (Standard plus H <sub>2</sub> measurement)
13582	3-Gas MGA 6010 for Corrosive Gases (Standard plus compatibility with NH <sub>3</sub> gas)
13583	4-Gas MGA 6010 for Corrosive Gases (Standard plus H <sub>2</sub> measurement and compatibility with NH <sub>3</sub> gas)

The following diagram illustrates the location of important internal components of the MGA 6010, along with relevant part numbers.

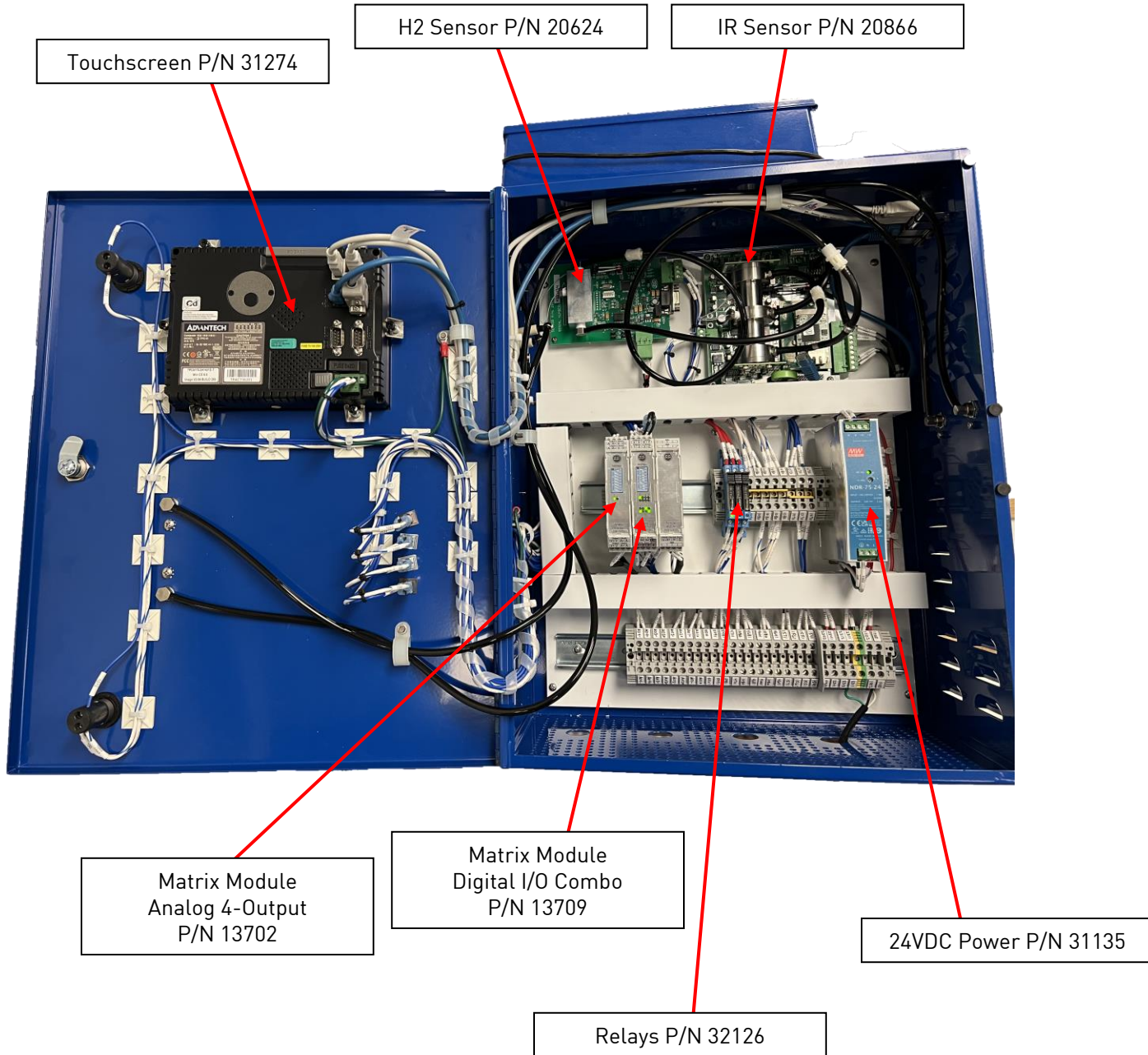

## Warranty

### *Limited Warranty for Super Systems Products:*

The Limited Warranty applies to new Super Systems Inc. (SSI) products purchased direct from SSI or from an authorized SSI dealer by the original purchaser for normal use. SSI warrants that a covered product is free from defects in materials and workmanship, with the exceptions stated below.

The limited warranty does not cover damage resulting from commercial use, misuse, accident, modification or alteration to hardware or software, tampering, unsuitable physical or operating environment beyond product specifications, improper maintenance, or failure caused by a product for which SSI is not responsible. There is no warranty of uninterrupted or error-free operation. There is no warranty for loss of data—you must regularly back up the data stored on your product to a separate storage product. There is no warranty for product with removed or altered identification labels. SSI DOES NOT PROVIDE ANY OTHER WARRANTIES OF ANY KIND, INCLUDING, BUT NOT LIMITED TO, THE IMPLIED WARRANTIES OR CONDITIONS OF MERCHANTABILITY AND FITNESS FOR A PARTICULAR PURPOSE. SOME JURISDICTIONS DO NOT ALLOW THE LIMITATION OF IMPLIED WARRANTIES, SO THIS LIMITATION MAY NOT APPLY TO YOU. SSI is not responsible for returning to you product which is not covered by this limited warranty.

If you are having trouble with a product, before seeking limited warranty service, first follow the troubleshooting procedures that SSI or your authorized SSI dealer provides.

SSI will replace the PRODUCT with a functionally equivalent replacement product, transportation prepaid after PRODUCT has been returned to SSI for testing and evaluation. SSI may replace your product with a product that was previously used, repaired and tested to meet SSI specifications. You receive title to the replaced product at delivery to carrier at SSI shipping point. You are responsible for importation of the replaced product, if applicable. SSI will not return the original product to you; therefore, you are responsible for moving data to another media before returning to SSI, if applicable. Data Recovery is not covered under this warranty and is not part of the warranty returns process. SSI warrants that the replaced products are covered for the remainder of the original product warranty or 90 days, whichever is greater.

#### **IMPORTANT!**

Do not use a MGA 6010 for gas analysis with NH<sub>3</sub>-containing gas if the MGA 6010 has not been configured with NH<sub>3</sub> compatibility. Any use of a non-NH<sub>3</sub> compatible MGA 6010 with NH<sub>3</sub>-containing gas will void the product warranty.

## Revision History

Rev.	Description	Date	MCO#
A	Initial Release	11/9/2011	N/A
B	General Information screen information updated with relevant screen shot added; wiring diagrams and piping diagram updated.	11/2/2012	2105
C	Updated for added nitriding calculations, available compatibility with ammonia gas. Updated parts list. Updated tools menu as needed. Updated to reflect IR Factor information. Added component diagram. Updated wiring and piping drawings. Removed O <sub>2</sub> references. Added Analog Output Setup. Added descriptions on Digital Inputs.	11/6/2014	2140
D	Added time zone and daylight savings note to General Setup	5-26-2017	2217
E	Added Register Map and Configuration Parameters Appendices, removed electrical diagram, corrected terminal numbers in Appendix B.	10/20/2017	2224
F	Added 9010 option, added wiring terminal details, added URL for electrical diagrams, added options to Furnace Temp and Probe Temp menus	4/25/2019	2262
G	Removed "Change Adjustment Factor" button	8/27/2020	2300
H	Added Kc/ammonia note	10/28/2021	2315
I	Updated specifications	2-15-2022	2319
J	Updated wiring table, relevant terminal callouts, parts list, Appendix B, removed Analog Input Calibration section	1/12/2023	2331
K	Updated Calculation Factors section to reflect correct Shim Factor	8/30/2023	2341
L	Corrected IR Sensor IP Address	10/23/2024	2361

## Appendix A: Piping Diagram

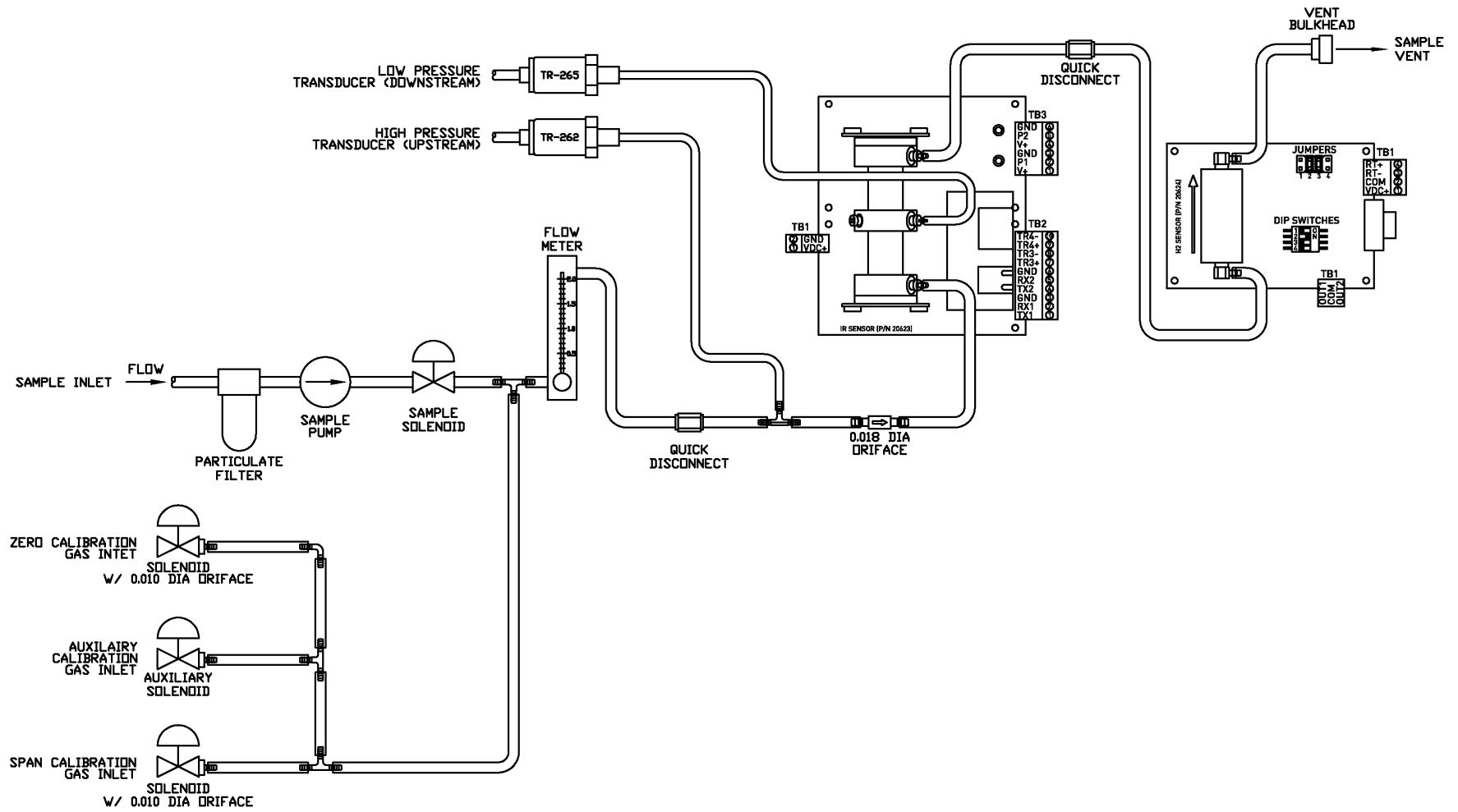

## Appendix B: Digital Inputs on the MGA 6010

There are four Digital Inputs on the MGA6010. These are usually tied to external events or activated by an external PLC. Each one has a different function as described below:

- **Digital Input #1 (Terminal 3721):** Inhibits the COF/PF adjustment. When this is enabled, no adjustments will be made to the COF/PF.
- **Digital Input #2 (Terminal 3701):** Turns the sample pump off. When this is enabled, the sample pump will turn off. If the pump is already off, then nothing will happen.
- **Digital Input #3 (Terminal 3681):** Initiates a Zero Calibration. When this is enabled, the MGA will stop current activities and begin a zero calibration via the Automatic Calibration Ports.
- **Digital Input #4 (Terminal 3661):** Initiates a Span Calibration. When this is enabled, the MGA will stop current activities and begin a span calibration via the Automatic Calibration Ports.

The digital inputs are enabled by completing the electrical connection between each input and the ground terminal (Terminal 1080).

*Example:* Assume that you want to turn the pump off at any time the door of the furnace is opened. You might add some open contacts on the relay that is being used to open the door, so that when that relay is activated, it connects terminal 3701 to terminal 1080. As long as the door is being held open, the pump will not turn on.

## Appendix C: Modbus Registers

Register	Description
0	firmware version x 100
1	RS232 host port Baud (terms 1,2,& 3)
2	RS232 host port; Modbus slave = 1, PGA3500 mode = 2
3	RS485 Slave port Baud (0 to 13 for 1200 to 921600)
4	RS485 Slave port; 0 = MMI master, 1 = Modbus master, 9 = Modbus slave, 10 = Modbus listen
5	Reserved
6	Reserved
7	RS485 port Baud (0 to 13 for 1200 to 921600)
8	RS485 port; Modbus master = 1, host port = 9
9	Internal Coms baud
10	Internal Coms Mode
11	RS232 port baud (terms 4,5,& 6)
12	RS232 port mode:Modbus slave = 1, Modbus master = 9
13	system mode: 0 = PGA, 1 = MGA, 2 = IR cell
14	Modbus address
15	degree
16	nitriter calculations enable
19	trim for the differential pressure
20	Item to display 1st on main display
21	Item to display 2nd on main display
22	Item to display 3rd on main display
23	Item to display 4th on main display
24	Item to display 5th on main display
25	Item to display 6th on main display
33	Baud set flag port F
34	enable pressure compensation
35	pressure trim value
38	ratio CO2 CO
39	Select CO2 for calculation: 0 = normal IR_gas[2] , 1 = high range IR_gas[4]
40	IR Dew point if calculated
41	Enable IR Dew point calculation
42	IR dew point factor
43	Startup pressure reading kPa * 100
44	elevation change from startup in feet * 10
45	Elevation from sea level in feet
46	pressure trim value
47	Local pressure entered for calibration



48	o2 calibration factor (2489 = .2489)
49	o2 zero offset
50	*50 - 53 Pressure reading at last calibration in kPa * 100
54	Adjust minimum temperature
55	Adjust minimum millivolts
56	Minimum MV action; 0 = only inhibits adjust and control
57	max adjust amount
58	maximum COF/PF
59	minimum COF/PF
60	mode: 0 = monitor, 1 = COF/PF adjust base on %C 2 = COF/PF adjust based on CO
61	User input scaled 4-20MA input
62	User input zero value (4MA)
63	User input span value (20MA)
64	flow zero offset
65	flow span value
67	process factor register
68	LED D2 ON time in milliseconds
69	LED D2 OFF time in milliseconds
71	cal enable
72	User input display decimal place
74	Web change enable; 0 = disable, 1 = enable
75	calibration stage
76	Pump ON delay
77	Sample OFF delay
78	Adjust/control update interval
79	sample ON delay time
80	H2 zero gas % times 100 (xx.xx)
81	H2 span gas % times 100 (xx.xx)
82	hydrogen cell calibration request; 1 = zero, 2 = span
83	H2 cell in % times 100 (xx.xx)
84	System DC Volts
85	power state
86	HMI State
98	Probe ATM Instrument: ; -1 = internal (Input 1 for MV Input 2 for TC), // -2 = internal (Input 1 for MV Input 3 for TC), 0 to Probe_ATM_max for external, use -3 for manual
99	Probe temperature instrument: -1 = internal (Input 3 for furn TC), // -2 = internal (Input 2 for furn TC), 0 to Probe_TC_max for external, use -3 for manual
100	local cooler ON set point
101	local cooler OFF set point

102	auto calibration and/or sequencing bit 0 = auto cal; 0 = OFF, 1 = ON bit 1 = sequencing; 0 = OFF, 1 = ON bit 2 = seq mode; 0 = normal; 1 = specific bits 4 - 7 N.U. bits 8 - 13 CH active bit map bits 14 - 15 N.U.
103	Auto cal interval in minutes 0 = OFF
104	Auto Zero interval in minutes 0 = OFF
105	Auto data display time at end of seq
106	purge time before cal or zero
107	if auto cal is avail this is 1
108	Auxiliary relays output desired states
109	relays output desired states // 0 = pump, 1 = Alarm 2, 2 = Alarm 1, 3 = Aux cal gas // 4 = Sample, 5 = ACZ zero gas, 6 = ACZ span gas, 7 = AC/cooler ON
110	Selected gas type; 0 = none
111	Reading for gas 1
112	Full scale range for gas 1
113	Decimal place location; low byte = display, hi = source
114	Span gas value for gas 1
115	see above
116	0 = blank, 1 = %, 2 = deg F, 3 = deg C,
120	Selected gas type; 0 = none
121	Reading for gas 2
122	Full scale range for gas 2
123	Decimal place location; low byte = display, hi = source
124	Span gas value for gas 2
125	see above
126	0 = blank, 1 = %, 2 = deg F, 3 = deg C,
130	Selected gas type; 0 = none
131	Reading for gas 3
132	Full scale range for gas 3
133	Decimal place location; low byte = display, hi = source
134	Span gas value for gas 3
135	see above
136	0 = blank, 1 = %, 2 = deg F, 3 = deg C,
140	Selected gas type; 0 = none
141	Reading for gas 4
142	Full scale range for gas 4
143	Decimal place location; low byte = display, hi = source

144	Span gas value for gas 4
145	see above
146	0 = blank, 1 = %, 2 = deg F, 3 = deg C,
150	Selected gas type; 0 = none
151	Reading for gas 5
152	Full scale range for gas 5
153	Decimal place location; low byte = display, hi = source
154	Span gas value for gas 5
155	see above
156	0 = blank, 1 = %, 2 = deg F, 3 = deg C,
160	Selected gas type; 0 = none
161	Reading for gas 6
162	Full scale range for gas 6
163	Decimal place location; low byte = display, hi = source
164	Span gas value for gas 6
165	see above
166	0 = blank, 1 = %, 2 = deg F, 3 = deg C,
170	Calculated value type type; 0 = none
171	Reading for CV 1
172	Full scale range for CV 1
173	Decimal place location; low byte = display, hi = source
174	Zero Scale value for CV 1
175	see above
176	0 = blank, 1 = %, 2 = deg F, 3 = deg C,
180	Calculated value type type; 0 = none
181	Reading for CV 2
182	Full scale range for CV 2
183	Decimal place location; low byte = display, hi = source
184	Zero Scale value for CV 2
185	see above
186	0 = blank, 1 = %, 2 = deg F, 3 = deg C,
190	Calculated value type type; 0 = none
191	Reading for CV 3
192	Full scale range for CV 3
193	Decimal place location; low byte = display, hi = source
194	Zero Scale value for CV 3
195	see above
196	0 = blank, 1 = %, 2 = deg F, 3 = deg C,
197	low alarm limit
198	high alarm limit
199	high range % CO <sub>2</sub> x100

200	% CO x100
201	%CO2 x10000
202	%O2 x10
203	%CH4 x100
204	Turn off bench, pump, and sample
205	IR %C
206	IR suggested COF
207	IR suggested PF
208	IR equivalent millivolts
209	probe MV
210	probe COF
211	probe temperature
212	probe process factor
213	probe %C
214	pump run minutes
215	pump run weeks
216	pump status
217	pump run now
218	pump run max
219	calibration status
220	IR temperature
221	control output in percent
222	sample flow
223	sample valve state
224	sample valve control
225	flow timer
226	Status of base; 0 = OFF, 1 = pump delay ON 2 = sample delay, 3 = measure delay 4 = delay OFF, 5 = ON
227	alarm bit map bit 0 = low flow; bit 1 = base communications bit 2 = max factor; bit 3 = min factor; bit 4 = PC_comp alarm ; bit 5 = auto cal alarm bit 6 = programmer alarm; bit 7 thru 15 = gas alarms. high byte is acknowledge
228	alarm bit map 2: bit 0 = FC TC; Bit 1 = PB TC bit 2 = PB MV; bit 3 = PB COF/PF bit 4 = PB %C; bit 5 = ambient temperature bit 6 = gas temperature bit 7 thru 15 not assigned.
229	alarm 1 assignment bit mask 0 = not assigned; 1 = assigned

230	alarm 2 assignment bit mask 0 = not assigned; 1 = assigned bits 0 to 6 are alarm_bit_map1 bits (0 to 6) bits 7 to 15 are alarm_bit_map bits (7 to 15) alarm_bit_map bits 0 to 6 are always alarm 1
231	local temperature x 10 in deg F or C based on degree
236	pressure data difference
237	number of entries in Que
238	pressure reading in kPa * 100
239	pressure difference due to elevation in kPa * 100
240	sea level (barometric) pressure
241	pressure in atmospheres * 1000
242	pressure in inHG * 100
243	external temperature x 10 in deg F or C based on degree
244	external oxygen data from O2 instrument
246	H2 cell communications status
247	UB check result
248	pressure sensor and calculation select; bits 0 to 3 = gage; 0000 = Std 36.3 PSI, 0001 = SS 50 PSI bits 4 to 7 = calculation; 0000 = on board absolute, 0001 = SPUD differential
249	pressure diff upstream to downstream in kPa * 100
250	Slave inst Type
251	Slave Inst Port
252	Slave inst address
514	year
515	month
516	day
517	day of week
518	hour
519	min
520	sec
530	Slave Coms Status
610	IR cell seq flag
611	IR calibration requests
612	calibration mode
613	calibration timer for purge, etc
614	calibration counter
615	calibration enable CO
616	calibration enable CO2
617	calibration enable CH4
618	calibration enable CO2H
620	calibration alarm bit map

640	calibration span gas 1
641	calibration span gas 2
642	calibration span gas 3
643	calibration span gas 4
644	calibration span gas 5
645	auto calibration span gas 2
646	auto calibration span gas 3
647	auto calibration span gas 4
648	auto calibration span gas 5
649	aux calibration span gas 2
650	aux calibration span gas 3
651	aux calibration span gas 4
652	aux calibration span gas 5
653	sample calibration span gas 2
654	sample calibration span gas 3
655	sample calibration span gas 4
656	sample calibration span gas 5
657	calibration gas source; 0 = auto, 1 = aux, 2 = sample with pump, 3 = sample w/o pump
666	internal use
667	internal use
668	ambient temperature trim; deg C * 100
669	gas (cell) temperature trim; deg C * 100
680	AIB Desired IN 1 Type
681	Desired IN 2 Type
682	Desired IN 3 Type
683	Desired IN 4 Type
684	Desired IN 5 Type
685	cal enable
686	CJ cal or zero/span voltage cal
687	Calibration Range register. Sets the voltage gain for a calibration.
688	bitmap of channels to be calibrated
689	Calibration value
690	AIBA Desired IN 1 Type
691	Desired IN 2 Type
692	Desired IN 3 Type
693	Desired IN 4 Type
694	Desired IN 5 Type
695	cal enable
696	CJ cal or zero/span voltage cal
697	Calibration Range register. Sets the voltage gain for a calibration

698	bitmap of channels to be calibrated
699	Calibration value
700	Gas Calorific Value x100 xx.xx
701	Gas Calorific Value factor for CO x1000 xx.xxx
702	Gas Calorific Value factor for CH4 x100 xx.xx
703	Gas Calorific Value factor for H2 x1000 xx.xxx
708	Kc CH4
709	Kc Boudouard
710	indicates that co data is valid
711	indicates that co2 data is valid
712	indicates that ch4 data is valid
713	High CO2 data valid
720	initiate carb Calc
721	alloy factor for calculation 10000 = 1.0000
722	default Hydrogen to use if no H2 cell 40% = 40.00
723	Surface carbon activity
724	Carbon with alloy factor = 1
725	Carbon with specified alloy factor
726	carbon calculated from only CO and CO2 with alloy factor = 1
727	carbon calculated from only CO and CO2 with supplied alloy factor
728	IR %C based on original 3 gas calculation
729	carb calc mode
730	IR factor mode; 0 = original factor, 1 = External factor, 2 = default table lookup, 3 = eternal table look up
731	IR shim factor
732	Pressure compensation factor; 0 = off, 10 = 1.0, max 2.0
733	CH4 factor
734	IR CO compensation factor
735	IR shim factor, working value
736	CH4 factor, working value
737	IR shim factor, External value
738	CH4 factor, External value
739	Calculation flag 0 = COF, 1 = Process Factor
740	pump ON delay timer
741	sample OFF delay timer
742	sample ON delay timer
743	interval timer for COF/PF adjust
744	pump mode; 0 = off, 1 = on, 2 = auto
750	Dac 1 assignment
751	Dac 2 assignment
752	Dac 3 assignment

753	Dac 4 assignment
754	Dac 1 zero
755	Dac 1 span
756	Dac 2 zero
757	Dac 2 span
758	Dac 3 zero
759	Dac 3 span
760	Dac 4 zero
761	Dac 4 span
770	furnace TC Low alarm limit
771	furnace TC High alarm limit
772	probe TC Low alarm limit
773	probe TC High alarm limit
774	probe MV Low alarm limit
775	probe MV High alarm limit
776	probe COF/PF Low alarm limit
777	probe COF/PF High alarm limit
778	probe %C Low alarm limit
779	probe %C High alarm limit
780	Ambient temperature Low alarm limit
781	Ambient temperature High alarm limit
782	Ambient temperature Low alarm limit
783	Ambient temperature High alarm limit
800	Gas1/Gas2 ratio
820	HiTech CO compensation ratio * 1000
821	HiTech CO2 compensation ratio * 1000
822	HiTech CH4 compensation ratio * 1000
825	Calculated new factor for COF/PF adjust
826	pump control; 0 = off, 1 = on
828	Bit 0 = CO Alarm Armed, Bit 1 = CO Alarm Alarm, Bit 2 = CO2 Alarm Armed, Bit 3 = CO2 Alarm Alarm, Bit 4 = CH4 Alarm Armed, Bit 5 = CH4 Alarm Alarm, Bit 6 = IR PC Alarm Armed, Bit 7 = IR PC Alarm Alarm
829	Bits 0 - 1 CO Alarm Bits 2 - 3 CO2 alarm, Bits 4 - 5 CH4 alarm, Bits 6 -7 IR PC alarm 00 = OFF, 01 = armed, 10 = timing, 11 = alarm



830	CO alarm type bits 0 - 1; 0 = off, 1 = band, 2 = dev bit 2 N/A bit 3 N/A control bits; bit 8 = armed, bit 9 = safe, bit 10 = timing, bit 11 = alarm bits 13 to 15 NU
831	CO alarm set point
832	CO alarm hysteresis
833	CO Minimum temperature for active alarm
834	CO Maximum temperature for active alarm
835	CO on delay time in seconds
836	CO center point for deviation and band alarms
837	CO alarm timer
840	CO2 alarm type bits 0 - 1; 0 = off, 1 = band, 2 = dev bit 2 N/A bit 3 N/A control bits; bit 8 = armed, bit 9 = safe, bit 10 = timing, bit 11 = alarm bits 13 to 15 NU
841	CO2 alarm set point
842	CO2 alarm hysteresis
843	CO2 Minimum temperature for active alarm
844	CO2 Maximum temperature for active alarm
845	CO2 on delay time in seconds
846	CO2 center point for deviation and band alarms
847	CO2 alarm timer
850	CH4 alarm type bits 0 - 1; 0 = off, 1 = band, 2 = dev bit 2 N/A bit 3 N/A control bits; bit 8 = armed, bit 9 = safe, bit 10 = timing, bit 11 = alarm bits 13 to 15 NU
851	CH4 alarm set point
852	CH4 alarm hysteresis
853	CH4 Minimum temperature for active alarm
854	CH4 Maximum temperature for active alarm
855	CH4 on delay time in seconds
856	CH4 center point for deviation and band alarms
857	CH4 alarm timer

860	%C alarm type bits 0 - 1; 0 = off, 1 = band, 2 = dev bit 2 N/A bit 3 N/A control bits; bit 8 = armed, bit 9 = safe, bit 10 = timing, bit 11 = alarm bits 13 to 15 NU
861	%C alarm set point
862	%C alarm hysteresis
863	%C Minimum temperature for active alarm
864	%C Maximum temperature for active alarm
865	%C on delay time in seconds
866	%C center point for deviation and band alarms
867	%C alarm timer
897	O2 cal span value %O2 x 10
898	O2 calibration req; 1 = zero, 2 = span
899	return code of UDPDL init()
900	product ID code
901	reset logging
902	Dynamic C compiler version in hex
903	long date/time stamp in secs from
904	midnight Jan 1, 1980.
905	Hack attempts counter
906	Web access code, level 1
907	Web access code, level 2
908	session ID passed to Java Applet
909	internal use
910	Force user block write; 0xa5 (165) = write w/o conf, 0xa9 (169) = write with config, 222 = write user setups, 444 = read user setups
914	4 locations for IP address (14 - 17)
918	4 locations for net mask (18 - 21)
922	4 locations for gateway (22 - 25)
930	10 locations for port states
940	auto calibration interval timer
941	auto zero interval timer
942	auto cal/zero request; bit 0 = zero, bit 1 = span
943	auto cal/zero sequence
944	sequence timer
945	auto cal/zero status
946	Flag to initiate log of Auto cal
947	Number of entries in Auto cal log file

980	4 locations for Time server IP address
984	UTC time zone as a quarter hour offset from UTC must be +/- 100 For EST with a -5 hour difference enter -20
985	UTC update interval in days (0 to 399) 0 disables
986	UTC update flag
987	UTC result
996	web page writes here as update indicator
1000-1099	atmosphere instrument
1100-1199	temperature instrument
1200-1299	spare instrument slot
1311	%H2 x100
1325	offset in H2_DACbase for first DAQ board/ DAC status = copy of COM_stat_X
1326	board address (lo Byte)/ baud rate; 0 = 9600, 1 = 19200 (hi Byte)
1327	DAC 0 zero calibration
1328	DAC 0 span calibration
1329	DAC 1 zero calibration
1330	DAC 1 span calibration
1331	DAC 2 zero calibration
1332	DAC 2 span calibration
1333	DAC 3 zero calibration
1334	DAC 3 zero calibration
1335	DAC 0 value
1336	DAC 1 value
1337	DAC 2 value
1338	DAC 3 value
1339	DAC version
1345	DAC Out 0
1346	DAC Out 1
1347	DAC Out 2
1348	DAC Out 3
1350	offset in H2_DACbase for second DAQ board/ DAC status = copy of COM_stat_X
1351	board address (lo Byte)/ baud rate; 0 = 9600, 1 = 19200 (hi Byte)
1352	DAC2 0 zero calibration
1353	DAC2 0 span calibration
1354	DAC2 1 zero calibration
1355	DAC2 1 span calibration
1356	DAC2 2 zero calibration
1357	DAC2 2 span calibration
1358	DAC2 3 zero calibration
1359	DAC2 3 span calibration
1360	DAC2 0 value

1361	DAC2 1 value
1362	DAC2 2 value
1363	DAC2 3 value
1364	DAC2 version
1370	DAC2 Out 0
1371	DAC2 Out 1
1372	DAC2 Out 2
1373	DAC2 Out 3
1400	Smart Power Sense Relay Board version number
1401	RS232: Determines mode: modbus slave = 0, modbus master = 1
1402	RS232: Values are from 0 to 2. 0 = 9600, 1 = 19200, 2 = 38400
1403	RS485: Determines mode: modbus slave = 0, modbus master = 1
1404	RS485: Values are from 0 to 2. 0 = 9600, 1 = 19200, 2 = 38400
1405	Temperature trim for thermistor 1
1406	A/D counts for thermistor 1
1407	thermistor 1 temperature
1408	%O2 A/D counts
1409	AIN 1 A/D counts
1410	AIN 2 A/D counts
1411	AIN 3 A/D counts
1412	Voltage monitor counts
1413	Relay outputs
1414	Board modbus address (important for slave only)
1415	Model number Map as reg 900
1416	internal use SFD
1417	DC Volts calculated from VMonitorCounts
1418	Power status for orderly shut down
1419	Power Control which way are we going.
1420	Power Timer
1421	Power Relays; bit 0 is HMI, Bit 1 is other Electronics
1422	SPUD System mode; 0 = plain Jane, 1 = H2, 2 = SDS
1423	Pump active (ON); 0 = no, 1 = yes
1424	Pump request; 0 = OFF, 1 = ON
1425	Pump flow measured
1426	Pump flow setpoint (0 to 1000)
1427	digital inputs active low
1428	Survey points
1429	degree
1430	timer for the SDS module
1431	Internal use
1432	Battery voltage counts

1433	Battery voltage
1434	DC voltage counts
1435	DC voltage
1436	Temperature trim for thermistor 2
1437	A/D counts for thermistor 2
1438	thermistor 2 temperature
1440	digital inputs active High bit 0 = COF/PF inhibit, bit 1 = pump stop, bit 2, = auto zero, bit 3 = auto span
1451	Smart AIB current version number of the firmware
1452	0 = °F, 1 = °C, 2 = °R, 3 = K
1453	Cold Junction Temperature
1458	Input type
1463	Process Variable
1468	enables a calibration
1469	CJ cal or zero/span voltage cal
1470	Calibration Range register. Sets the voltage gain for a calibration.
1471	bitmap of channels to be calibrated
1472	First of 5 Calibration value
1477	First of 5 calibration timers
1482	0 = no calibration, 1 = calibration in progress
1483	First of 5 calibration error calculations
1487	End of calibration registers
1488	First of 5 Scaled VDC
1498	message update flag
1499	calculation sequence
1500	Com status message 1
1504	Com status message 2
1516	A/D 1 status register (negative)
1517	A/D 1 reading on
1519	A/D 1 status register (positive)
1520	A/D 1 reading off
1522	A/D 2 status register (negative)
1523	A/D 2 reading on
1525	A/D 2 status register (positive)
1526	A/D 2 reading off
1528	A/D 3 status register (negative)
1529	A/D 3 reading on
1531	A/D 3 status register (positive)
1532	A/D 3 reading off
1534	A/D 4 status register (negative)
1535	A/D 4 reading on

1537	A/D 4 status register (positive)
1538	A/D 4 reading off
1540	IR trigger time
1541	time from off to on
1542	A/D selector
1543	ambient temperature raw counts (10 bits resolution)
1544	ambient temperature trim
1545	gas temperature raw counts (10 bits resolution)
1546	gas temperature trim
1547	absolute pressure raw counts (10 bits resolution)
1548	absolute pressure trim
1549	differential pressure raw counts (10 bits resolution)
1550	differential pressure trim
1551	digital status word
1552	Baud Rate selection variable
1600	Block Gas 1 value
1601	Block Gas 2 value
1602	Block Gas 3 value
1603	Block Gas 4 value
1604	Block Gas 5 value
1605	Block Gas 6 value
1606	Block Calculated Value 1
1607	Block Calculated Value 2
1608	Block Calculated Value 3
1609	Block IR %C
1610	Block IR suggested COF
1611	Block IR suggested PF
1612	Block IR equivalent millivolts
1613	Block probe MV
1614	Block probe COF
1615	Block probe temperature
1616	Block probe process factor
1617	Block probe %C
1618	Block IR temperature
1619	Block sample flow
1620	Block alarm bit map
1621	Block mode: 0 = monitor, 1 = COF/PF adjust base on %C, 2 = COF/PF adjust based on CO
1622	Block auto cal/zero sequence
1623	Block auto cal/zero status
1628	Block Request for pump mode; 0 = no request, 1, 2, & 3 = 0, 1,2 in pump_mode
1629	Block Request for IR mode; 0 = no request, 1, 2, & 3 = 0, 1,2 in IR_mode

1650	Block W Gas 1 value
1651	Block W Gas 2 value
1652	Block W Gas 3 value
1653	Block W Gas 4 value
1654	Block W Gas 5 value
1655	Block W Gas 6 value
1656	Block W Calculated Value 1
1657	Block W Calculated Value 2
1658	Block W Calculated Value 3
1659	Block W IR %C
1660	Block W IR suggested COF
1661	Block W IR suggested PF
1662	Block W IR equivalent millivolts
1663	Block W probe MV
1664	Block W probe COF
1665	Block W probe temperature
1666	Block W probe process factor
1667	Block W probe %C
1668	Block W IR temperature
1669	Block W sample flow
1670	Block W alarm bit map
1671	Block W mode: 0 = monitor, 1 = COF/PF adjust base on %C, 2 = COF/PF adjust based on CO
1672	Block W auto cal/zero sequence
1673	Block W auto cal/zero status
1699	Block Write Timer
1704	Digital Output 1 setpoint
1705	Digital Output 1 actual
1706	Digital 1 Input
1714	Digital Output 2 setpoint
1715	Digital Output 2 actual
1716	Digital 2 Input
1724	Digital Output 3 setpoint
1725	Digital Output 3 actual
1726	Digital 3 Input
1799	Set Point register
1801	Flow Meter 1 Flow
1803	Flow Meter 1 Set Point
1811	Flow Meter 2 Flow
1813	Flow Meter 2 Set Point
1821	Flow Meter 3 Flow
1823	Flow Meter 3 Set Point

1831	Flow Meter 4 Flow
1833	Flow Meter 4 Set Point
1841	Flow Meter 5 Flow
1843	Flow Meter 5 Set Point
1851	Flow Meter 6 Flow
1853	Flow Meter 6 Set Point
1861	Flow Meter 7 Flow
1863	Flow Meter 7 Set Point
1871	Flow Meter 8 Flow
1873	Flow Meter 8 Set Point
8900	ambient temperature; deg F x 100
8901	gas (cell) temperature, deg F x 100
8902	cell abs pressure
8903	cell differential pressure
8904	gas 1 peak to peak (first of 5)
8909	gas 1 level at zero (N2) (first of 5)
8914	gas 1 gain constant from span (first of 5)
8919	gas 1 reading with compensation (first of 5)
8924	gas 1 value (first of 5)
8929	gas 1 pos (first of 5)
8934	gas 1 neg (first of 5)
8939	gas 1 value with TC adjust (first of 5)
8944	gas 1 value with press adjust (first of 5)
8949	gas 1 value with both (first of 5)
8954	temperature ratio Tcal/T (first of 5)
8959	pressure ratio P/Pcal (first of 5)
8964	filter time in MS (first of 5)
8969	Integer of calibration average (first of 5)
8974	Integer of gas read at ave (first of 5)
8989	Ambient temperature pre-trim
8990	Gas temperature pre-trim
8991	Normalized Absorbance (CH4)
8992	Normalized Absorbance (CO2)
8993	Normalized Absorbance (CO)
8994	Normalized Absorbance (CO2 -h)
8995	gas 1 p2p raw
9100	Gas 1 Name
9110	Gas 2 Name
9120	Gas 3 Name
9130	Gas 4 Name
9140	Gas 5 Name



9150	Gas 6 Name
9160	Calculated Value 1 Name
9170	Calculated Value 2 Name
9180	Calculated Value 3 Name
9191	Queue 1 Status
9192	Queue 2 Status
9193	Queue 3 Status
9194	Queue 4 Status
9195	Queue 5 Status
9196	Queue 6 Status
9197	Queue Instrument Number
9198	Queue Register
9199	Queue Data
19800	IR factor default ATM setpoint 1
19801	IR factor default ATM setpoint 2
19802	IR factor default ATM setpoint 3
19803	IR factor default ATM setpoint 4
19804	IR factor default TC setpoint 1
19805	IR factor default TC setpoint 2
19806	IR factor default TC setpoint 3
19807	IR factor default TC setpoint 4
19808	IR factor default factor 11
19809	IR factor default factor 12
19810	IR factor default factor 13
19811	IR factor default factor 14
19812	IR factor default factor 21
19813	IR factor default factor 22
19814	IR factor default factor 23
19815	IR factor default factor 24
19816	IR factor default factor 31
19817	IR factor default factor 32
19818	IR factor default factor 33
19819	IR factor default factor 34
19820	IR factor default factor 41
19821	IR factor default factor 42
19822	IR factor default factor 43
19823	IR factor default factor 44
19850	IR factor external ATM setpoint 1
19851	IR factor external ATM setpoint 2
19852	IR factor external ATM setpoint 3
19853	IR factor external ATM setpoint 4

19854	IR factor external TC setpoint 1
19855	IR factor external TC setpoint 2
19856	IR factor external TC setpoint 3
19857	IR factor external TC setpoint 4
19858	IR factor external factor 11
19859	IR factor external factor 12
19860	IR factor external factor 13
19861	IR factor external factor 14
19862	IR factor external factor 21
19863	IR factor external factor 22
19864	IR factor external factor 23
19865	IR factor external factor 24
19866	IR factor external factor 31
19867	IR factor external factor 32
19868	IR factor external factor 33
19869	IR factor external factor 34
19870	IR factor external factor 41
19871	IR factor external factor 42
19872	IR factor external factor 43
19873	IR factor external factor 44

## Appendix D: Configuration Parameters

<b><u>Pump Control</u></b>	
Pump Status	Auto
Pump On Delay (seconds)	2
Pump Off Delay (seconds)	2
<b><u>Automatic Sampling Parameters</u></b>	
COF/PF Adjustment Increment	1
COF/PF Adjustment Interval	1
Minimum COF/PF Value	130
Maximum COF/PF Value	220
COF/PF Adjustment Mode	Monitor
Minimum Temperature for sampling	1490 °F
Minimum Millivolts for sampling	1030 mV
Minimum millivolt condition...	also stops pump
<b><u>Communication and Source Setup / IP Address</u></b>	
IR Sensor IP Address	192.168.1.221
<b><u>Communication and Source Setup / Temp Sources</u></b>	
Port usage	Modbus Master
Port Baud Rate	19200

Probe Temp/mV Instrument	SSI AC20
Probe Temp/mV Instrument Address	0
Furnace Temp/mV Instrument	Ssi 7EK
Furnace Temp/mV Instrument Address	0
<b><u>Instrument Setup / Calculation Factors</u></b>	
IR Factor	CO Factor
IR Shim Factor	180
CH4 Factor	20
Use IRF Matrix	FALSE
Use Furnace Temp for Furnace Setpoint	FALSE
<b><u>Instrument Setup / General Setup</u></b>	
Temperature Units	°F
<b><u>Instrument Setup / Security Settings</u></b>	
Supervisor passcode	1
Configuration passcode	2
<b><u>Instrument Setup / Other Settings</u></b>	
Enable dew point calculation	Off
<b><u>IF NITRIDER CALCULATION IS ENABLED:</u></b>	
<b><u>Tools / Valve Setup</u></b>	
Valve 1 Maximum	
Valve 1 Decimal Place	
Valve 1 Gas	
Valve 2 Maximum	
Valve 2 Decimal Place	
Valve 2 Gas	
Valve 3 Maximum	
Valve 3 Decimal Place	
Valve 3 Gas	
Valve 4 Maximum	
Valve 4 Decimal Place	
Valve 4 Gas	
<b><u>Nitrider Calculation</u></b>	
N2 Flow	0
NH3 Flow	0
DA Flow	0
CO2 Flow	0